

Thermoplastic Hoses for Ultra High Pressure

Catalogue 4462 Global Edition



ENGINEERING YOUR SUCCESS.



Introduction and General Statements

<i>How to use the catalog</i>	II
<i>Part number system</i>	IV
<i>Explanation of symbols</i>	V
<i>User Manual for the Application of Hose Assemblies</i>	VI
<i>Polyflex Division</i>	XII
<i>Why use Parker thermoplastic hose?</i>	XIII
<i>Value added services</i>	XIX



Hose and Fitting Selection

<i>Hose selection chart by working pressure – design factor >2:1</i>	A – 2
<i>Hose selection chart by working pressure – design factor 4:1</i>	A – 4
<i>Hose fitting chart</i>	A – 5



Hoses with design factor 4:1



Hoses with design factor >2:1



Polyflex-Lok

<i>Polyflex-Lok components</i>	D – 2
--------------------------------------	-------



Accessories

<i>Heavy duty abrasion cover</i>	E – 2
<i>Heavy duty abrasion cover sleeves</i>	E – 2
<i>Spring guards</i>	E – 3
<i>Support grips</i>	E – 3
<i>PVC-S – Anti-abrasion sleeve</i>	E – 4
<i>HS - Containment grips</i>	E – 4
<i>UHPLABEL – Precautions for ultra-high pressure applications</i>	E – 4

F

Technical Information

Installation tips **F - 2**
Selection, installation, and maintenance of polyflex hose **F - 3**
Dash sizes **F - 4**
Selection of hose diameter from flow rate and velocity **F - 5**
Pressure drop **F - 6**
Glossary **F - 11**
Permeability coefficient **F - 12**
Recommended tightening procedures **F - 13**
Metric conversion chart **F - 14**
General chemical resistance table **F - 15**
Parker Safety Guide **F - 20**

G

Index of Part Numbers

Index **G - 1**
Safety note **G - 16**

The content contained in this catalogue has been compiled with the greatest care and corresponds to the information currently available to us.

However, we would like to point out that we reserve the right to make technical changes and we kindly request you to contact us should you have any special questions.

How to use the catalogue

Overall structure of the catalogue:

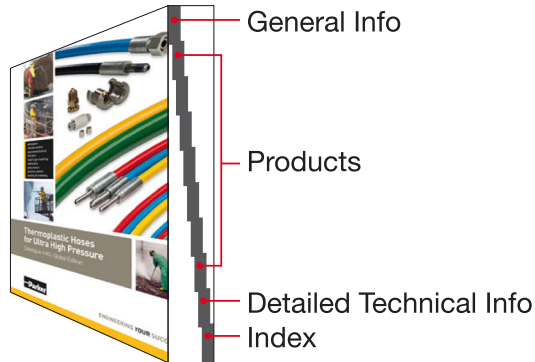

Hoses with safety factor 2.5:1
2440D / 2440N

2440D / 2440N - Ultra-high pressure hose



CONSTRUCTION Core tube : DN 3-8: Polyoxymethylene; DN 10-25: Polyamide
Pressure reinforcement : Four spiral layers of maximum tensile steel wire
Cover : Polyamide
Standard colour : DN 3-8: blue; DN 10-25: black

TEMPERATURE RANGE -10°C up to +70°C

Safety Factor 2.5:1

#	DN		size		mm		inch		MPa		psi		mm		kg/m
	mm	inch	mm	inch	mm	inch	mm	inch	MPa	psi	MPa	psi	mm	kg/m	
2440D-02V32	3	-02	3.0	1/8	7.9	3/16	10.4	1/2	207	30,000	518	75,000	100	0.12	
2440D-025V32	4	-025	4.0	5/32	11.5	3/16	12.5	1/2	220	31,900	550	79,750	100	0.21	
2440D-03V32	5	-03	4.8	3/16	11.5	1/4	15.1	1/2	180	26,100	450	65,250	130	0.28	
2440D-04V32	6	-04	6.4	1/4	12.5	5/16	15.1	1/2	164	23,780	410	59,450	155	0.33	
2440D-05V32	8	-05	8.1	5/16	15.1	3/8	19.4	1/2	150	21,750	375	54,375	175	0.44	
2440N-06V30	10	-06	9.7	3/8	19.4	1/2	22.5	1/2	140	20,300	350	50,750	190	0.73	
2440N-08V30	12	-08	12.8	1/2	22.5	3/4	30.0	1	130	18,850	325	47,125	200	0.94	
2440N-12V30	20	-12	19.6	3/4	30.0	1	37.0	1	100	14,500	250	36,250	250	1.39	
2440N-16V30	25	-16	25.0	1	37.0	1	37.0	1	90	13,050	225	32,625	300	2.00	

NOTES -

C-36 Catalogue 4462 Global Edition



Hose data is always colored in blue

Chapter selector
if you know the chapter you are looking for
– this is the quickest way to get there



Shows the current chapter

1AYLX – Type “M” female swivel

Hoses with safety factor 2.5:1
6AYLX / 1AYLX

MATERIAL High strength carbon steel, zinc plated

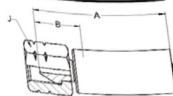

#	⊙		⌘		A	B	J	⌚	Nipple ID	Ferrule OD		
	DN	size	mm	inch							mm	mm
1AYLX-6-02	3	-02	3.0	1/8	9/16 - 18UNF	48	26	22	207	30,000	1.5	9.8
1AYLX-6-025	4	-025	4.0	5/32	9/16 - 18 UNF	64	26	22	220	31,900	1.4	14.6
1AYLX-6-03	5	-03	4.8	3/16	9/16 - 18UNF	66	26	22	180	26,100	1.4	15.3
1AYLX-6-04	6	-04	6.4	1/4	9/16 - 18UNF	61	29	22	164	23,780	2.9	17.0
1AYLX-8-05	8	-05	7.9	5/16	3/4 - 16UNF	74	30	27	150	21,750	3.7	21.0
1AYLX-8-06	10	-06	9.5	3/8	3/4 - 16UNF	70	26	27	140	20,300	5.8	26.9
1AYLX-11-08	12	-08	12.7	1/2	1 - 12 UNF	80	27	32	130	18,850	6.7	30.7
1AYLX-16-12	20	-12	19.0	3/4	1 5/16-12UNF	82	29	41	100	14,500	12.7	38.5

Safety Factor 2.5:1

Category selector
– superordinates chapters
into product groups

6AYLX / 1AYLX – Type “M” female swivel

MATERIAL Stainless steel

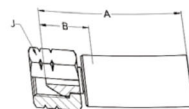

#	⊙		⌘		A	B	J	⌚	Nipple ID	Ferrule OD		
	DN	size	mm	inch							mm	mm
6AYLX-6-2AC	4	-025	4.0	5/32	9/16 - 18 UNF	64	33	17	220	31,900	??	??
1AYLX-6-03C	5	-03	4.8	3/16	9/16 - 18 UNF	67	26	22	180	26,100	1.4	15.3
1AYLX-6-04C	6	-04	6.4	1/4	9/16 - 18UNF	61	29	22	164	23,780	2.9	17.0
1AYLX-8-05C	8	-05	7.9	5/16	3/4 - 16 UNF	70	31	27	150	21,750	3.7	21.0
1AYLX-8-06C	10	-06	9.5	3/8	3/4 - 16 UNF	70	25	27	140	20,300	5.8	26.9
1AYLX-11-08C	12	-08	12.7	1/2	1 - 12 UNF	80	27	32	130	18,850	6.7	30.7
1AYLX-16-12C4462	20	-12	19.0	3/4	1 5/16-12 UNF	82	29	41	100	14,500	12.7	38.5
6AYLX-16-16C	25	-16	25.4	1	1 5/16 - 12 UNF	100	47	38	90	13,050	17.2	45.3



Fitting data is always colored in yellow

Part number system

Hoses

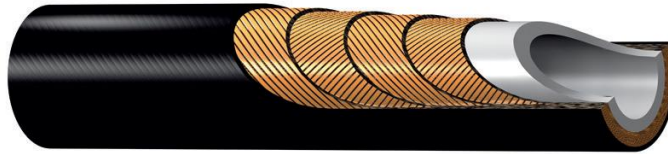

2440 N - 16 V91



Fittings

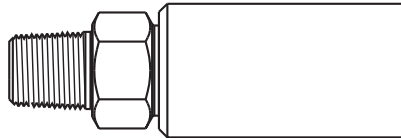



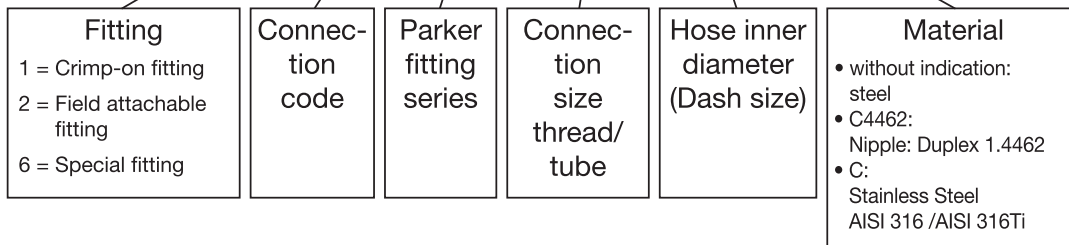





6 01 LX - 8 - 8 C



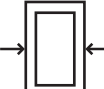

Explanation of symbols

Symbol	Description
#	Part number
	Nominal inner diameter
	Nominal outer diameter
	Working pressure
	Burst pressure
	Bend radius
	Weight
	Fittings
	Thread size
	Wrench size
	Thickness

User Manual for the Application of Hose Assemblies for High-Pressure Water Jet Machines

This User Manual has been prepared according to the requirements of EN 1829-2: 2008 High-Pressure Water Jet machines – Safety Requirements – Part 2: Hoses, Hose Lines and Connectors. It contains instructions on the proper use of hose assemblies made by Parker Hannifin GmbH, Polyflex Division, for high pressure water-jetting applications. Never use hose assemblies without thoroughly reading and understanding this User Manual. Any additional safety requirements issued by machine manufacturers, trade associations etc. must be complied with. We recommend wearing protective clothing.

1. Hazard notice
2. Description
3. Marking
4. Assembly and installation, proper use
5. Storage and utilization time of hose assemblies
6. Maintenance, repair, inspection, periodic pressure tests

1. Hazard notice

Hazards due to escaping media

- Media escaping at high pressure can cause personal injury and property damage.
- The escape of flammable media can cause fire.
- The escape of toxic media can cause intoxication if these are inhaled or ingested.

Hazards because of whipping hose assemblies

- If after break of the hose assembly the pressure is not immediately reduced to zero, the hose starts whipping, which may cause personal injury or property damage.

Hazards due to change in length of the hose assembly

- In the event of a sudden pressure change in the hose assembly, its length may change by $\pm 2\%$. This may lead to the operators losing their safe foothold.

Hazards due to incorrect behavior of operator

- Hazards may arise from the use of unsuitable substances or components by the operator, especially in case the application limits defined by the manufacturer are exceeded (e.g. too high pressure, too high tensile loads).

2. Description

The hose assemblies are made from high-pressure hose and the corresponding fittings by Parker Polyflex and the company's trained and certified distributors in compliance with Parker assembly instructions. They are pressure tested after completion. Upon customer's request, the hose assemblies can be equipped with protective sleeves or other safety equipment such as containment grips.

3. Marking

- The hose bears a factory marking specifying the manufacturer, the maximum working pressure, the part number, nominal size, batch number and the date of manufacture (quarter/year). The marking may include additional information.
- Protective sleeve has no marking as a standard.
- On its crimping shell or marking sleeve, the hose assembly bears a marking specifying the manufacturer, the maximum working pressure, the month and year of manufacture and the standard "EN 1829-2".

The working pressures of both hoses and fittings are limited. In rare cases, fittings with a lower working pressure than the hose may be used. In this case the hose assembly bears an additional warning. For the application of the hose assembly, it is not the pressure stated on the hose but the pressure on the crimping shell and/or marking sleeve that is relevant.

4. Assembly and installation, proper use

Assembly and installation

To ensure the proper function of hose assemblies and in order not to shorten their life by additional strain, the following instructions need to be followed:

- The maximum working pressure shall not be exceeded.
- The hose shall not be bent to less than its minimum bend radius.
- Do not kink or twist hose assemblies. Especially when long hose assemblies are routed, loops may form which can lead to kinks in the hose when pulled. Parker manufactures special fittings (Polyflex-Lok) which minimize this problem.
- Under pressure, any hose may become shorter or longer. Change in length of Parker hoses is in the range of approx. 2%.
- Before installing a hose assembly, make a visual inspection of the following:
 - o The working pressure of the hose assembly corresponds to the pressure of the pump.
 - o The hose cover does not show any damage.
 - o The fittings do not show any signs of corrosion.
 - o Threads and sealing faces are not damaged or dirty.
 - o O-rings are available and not damaged.
- Make sure that the connecting thread of the fitting matches its counter-piece.
- Do not remove protective caps until immediately prior to assembly.
- When mounting the fitting, slightly grease the threads of the fitting and the adapter to prevent cold welding (seizing).

When putting the hose assembly into operation, slowly build up the pressure and check the assemblies for leaks.

Proper use

Operating medium: Parker High Pressure hose assemblies are designed for use with water. For information about use with other media, please contact your Parker distributor – Parker's range includes special hoses which are suitable for e.g. corrosive media.

Temperature: The hose assemblies are designed for safe operation at temperatures from -10 to +70°C. If you wish to operate the hose assembly beyond this range, please contact your Parker distributor. Parker's range also includes special hoses suitable for higher temperatures. If hose assemblies are operated at low temperatures, no problems should be expected with the hose assemblies themselves; however, measures should be taken to prevent the operating medium from freezing.

Trouble-shooting: Immediately eliminate any leakage on the connectors (refasten connectors, replace O-rings, if necessary, or rework the cone).

Caution: Prior to performing any work, always relieve the pressure – never work on hose assemblies while they are under pressure. Should the leakage occur in the hose (blisters in the hose cover, leaks at the relief holes of the fitting) put the hose assembly out of operation immediately.

Continued use of a leaky hose assembly exposes the operators to serious hazards.

Special types of application: When used in tall buildings, hose assemblies have to be supported to prevent tensile stress. If hose assemblies are used under tensile stress, this will shorten their life.

When using hose assemblies in potentially explosive atmospheres, it needs to be considered that Parker high-pressure hose assemblies are electrically conductive in general (from fitting to fitting). However, neither the protective sleeves nor the hose cover are electrically conductive.

5. Storage and utilization time of hose assemblies

Even if properly stored and operated at permissible loads, hose assemblies are subject to natural ageing. This limits their storage and utilization time. Improper storage, mechanical damage and excessive stress are the most frequent causes of failure.

For the storage of hose assemblies, the following instructions shall be followed:

- Store the hose assemblies in a cool and dry place with low levels of dust.
- Do not expose the hose assemblies to direct sunlight or UV radiation.
- Protect the hose assemblies from heat sources.
- Do not use any ozone-generating luminaries (fluorescent sources of light, mercury vapor lamps) or electrical devices in the immediate vicinity of hose assemblies.
- Store hose assemblies stress-free and in a horizontal position.
- When storing hose assemblies in bundles, the hose shall not be bent to less than its minimum bend radius.
- Store fittings with protective caps to prevent damage to the thread.

The maximum storage time of bulk hose is 10 years and that of completed hose assemblies is up to 2 years. If possible, storage of hose assemblies should be avoided. The natural properties of the hose materials cause a loss of compression in the fitting, which may lead to premature leakage of the fitting.

Utilization period and replacement intervals

Parker does not limit the utilization period of a hose assembly, however it should not exceed 6 years.

Hose assemblies are used in a great variety of applications. For this reason Parker Polyflex is unable to guarantee a specific useful life of the hose assembly in a particular application.

The following guidelines may be useful:

- a) Parker Polyflex hose assemblies meet, or in most cases, exceed the requirements of DIN EN 1829-2. This standard prescribes that hose assemblies have to resist at least 20,000 cycles from zero to working pressure. This is relevant for industrial applications (e.g. cleaning of parts in the automotive industry) where hose assemblies are used on a permanent basis. In this case, no periodic pressure tests are required, but periodic visual inspections are recommended. The intervals for visual inspection and replacement must be determined by the manufacturer of the plant.
- b) In the construction industry (e.g. concrete refurbishment) and in flexible guns, hose assemblies are usually exposed to additional stress (e.g. tensile loads, mechanical damage) which may considerably reduce their useful life. Therefore the tests according to Section 6 are mandatory.

6. Maintenance, repair, inspection, periodic pressure tests

Prior to the first putting into operation and at least every six months:

Check the hose assemblies for their function and as to whether they can be safely used.

This inspection should be done by a skilled person, who due to professional training and experience has sufficient knowledge about hoses.

Scope of tests: visual inspection of the hose assemblies. Check whether the working pressure of the hose assembly corresponds to the actual working pressure of the application and whether the hose assembly shows any visible damage. Visible damage may include:

- Damage of the hose cover (e.g. abrasion, cuts or cracks).
- Deformation beyond the natural shape of the hose assembly in depressurized or pressurized state or during bending. This may include separation of layers, blisters, crushed or kinked hose.
- Damage or deformation of the fitting.
- Corroded fitting.
- Hose detaching from the fitting.
- Maximum storage and utilization times have been exceeded.

Daily:

- Visual inspection of the hose assemblies by the operator (see above)

Upon discovery of any visible damage, replace the hose assembly or have it approved for further use by a qualified person.

According to EN 1829-2 hose assemblies whose cover is so badly damaged that the wire reinforcement becomes visible have to be withdrawn from service. Repair of the hose cover is not allowed.

Yearly:

In addition to the visual inspection of the hose assembly, a pressure test with 1.2 x the working pressure has to be performed with this pressure being applied for two minutes. This pressure test is not required for hose assemblies in continuous use (industrial plants).

Repair of hose assemblies

Parker Polyflex advises against the repair of hose assemblies as the safety of a hose assembly that has already been in service is always reduced.

7. Polyflex-Lok

Polyflex-Lok is a system designed for the fast mounting of hose assemblies and/or for the connection of the hose assemblies to the pump / gun without any tools.

The system for connecting hose assemblies consists of hose assemblies (equipped with protective sleeve as a standard) with special connectors and protective caps, connection sleeves and shells.

Assembly:

Remove the protective caps from the hose connectors.

Slightly grease the hose connectors or wet them with some water and push them into the connection sleeve up to the stop. **CAUTION:** Make sure that all parts are perfectly clean and free from dirt and damage or deposits. Otherwise proper tightness and/or easy disassembly cannot be ensured. If necessary, clean the parts prior to assembly.

Close the shells over the connection sleeve.

Pull the hose assemblies apart (important, as otherwise the protective caps cannot be mounted) and mount the protective caps between the shells and the clamping sleeves for the protective sleeve.

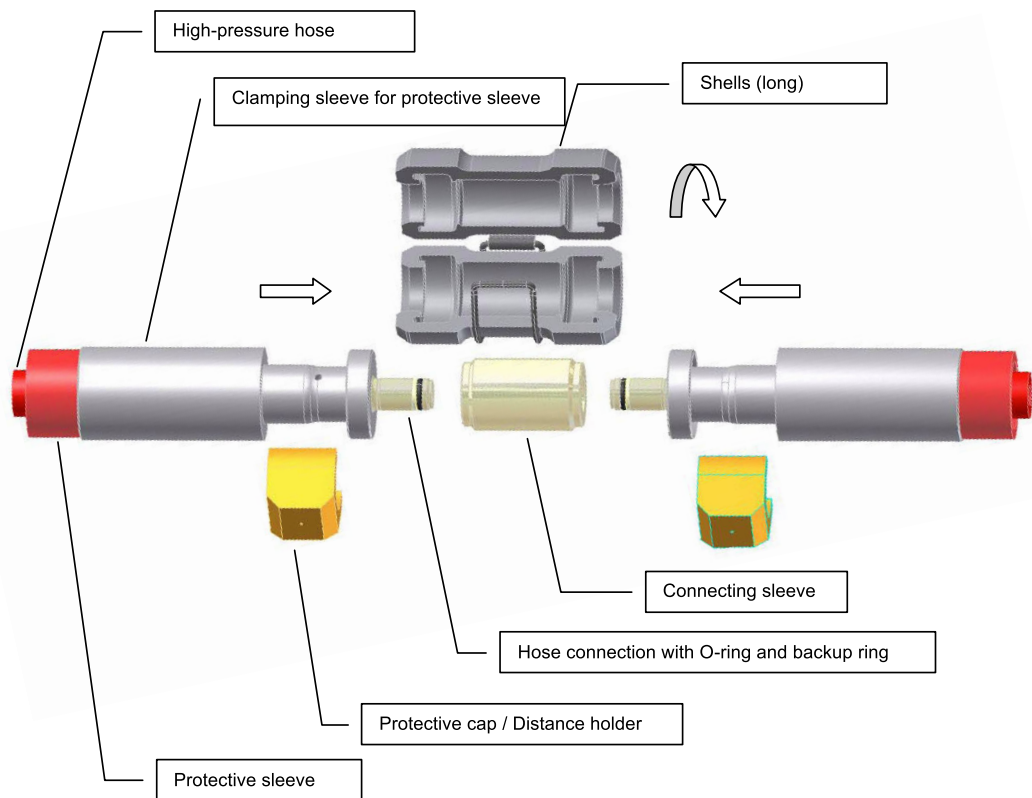



Disassembly:

Remove the protective caps.

Push the hose assemblies together up to the stop as otherwise the shells cannot be opened.

Open the shells and remove them.

Pull the hose connectors out of the connecting sleeve and immediately place the protective caps on the hose connectors.

The Polyflex-Lok system for the connection of the hose assembly to the pump / gun is designed according to the same principle. An adaptor is screwed onto the pump; a hose assembly is pushed into the adaptor and fixed with shells and a cap. Here as well cleanliness is mandatory.

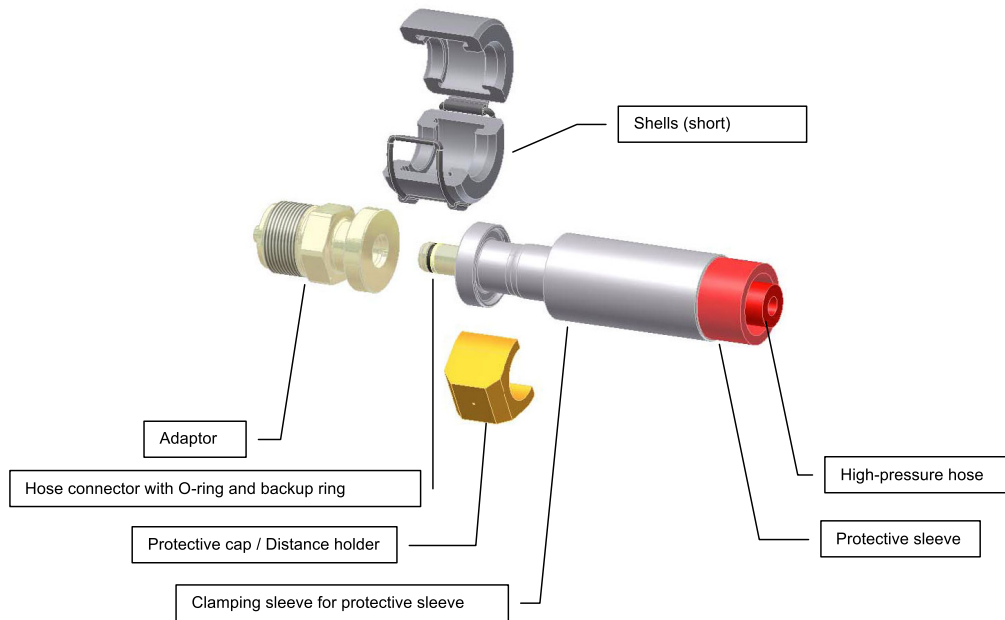

Parker Hannifin – Polyflex Division

Parker Hannifin offers an extensive programme of systems and components for fluid technology. Parker is structured by sales offices and manufacturing divisions to guarantee optimum focus on our customers' demands and market interests at any time.

The Polyflex division, with headquarters located in Hüttenfeld, Germany, provides thermoplastic hoses and tubes. These are applied in a variety of different markets such as standard hydraulics, ultra high pressure applications, and oil & gas industry. As a market leader in many areas and with a unique product range we are pleased to assist you with all your queries.

This catalogue includes hoses for high and ultra high pressure applications. The indicated fittings are always adapted to the correspondent hose and offer optimum performance.

Other catalogues with thermoplastic hoses

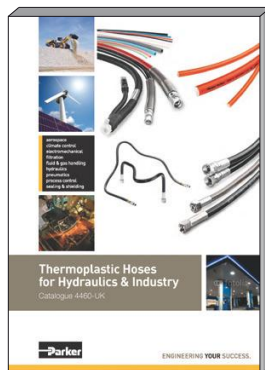

Catalogue 4460-UK

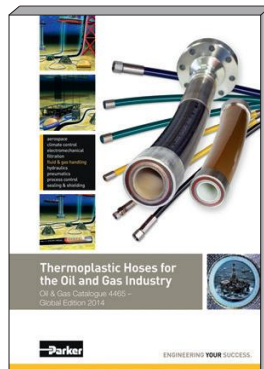

Catalogue 4465-UK

Why use Parker thermoplastic hoses?

Parker thermoplastic hose is the right answer for many technical challenges. With unique features and performance characteristics thermoplastic hose outperforms even established alternatives. Whether the task requires extreme temperatures, pressures, robustness or special custom designs, these hoses will not disappoint you.

See below the benefits offered by our complete hose range – also products featured in other catalogs – shown in comparison to other standard hose types :

Temperature Range

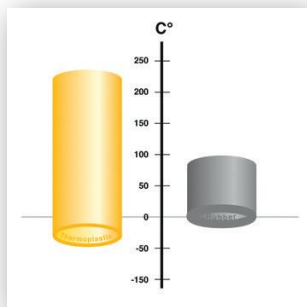

- Operating temperatures ranging from -50°C up to +230°C
- Best choice for dynamic applications even at very low temperatures
- Full working pressure even at extreme temperatures



Chemical Resistance



- Chemically inert, no interaction with the media
- Resistant against virtually all acids and alkalines



Abrasion



- Outer covers to withstand extreme wear
- Superior resistance and extended service life

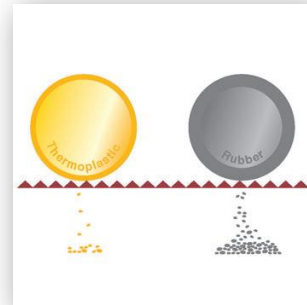

UV / Ozone & Seawater Resistance



- Build for harsh and exposed installations
- Environmental influences have minimal effect on hose life



Compact OD



- Space saving due to very small diameters
- Optimized routing and design in constricted installation spaces
- Prevent using overdimensioned hoses





Small ID



- Only thermoplastic hoses allow small IDs down to below 2mm
- Space saving
- Offers improved technical solutions in constricted installation spaces



Low Weight



- Major weight savings
- Energy savings as less mass needs to be moved



Non-Conductive



- Mandatory safety feature for applications with high voltage and high frequency
- Electrically isolating according to SAE J517



Customization

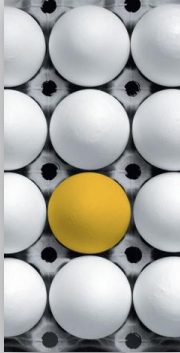

- Multiple colors
- Twin and multiple lines
- Hose bundles
- Customer specific designs

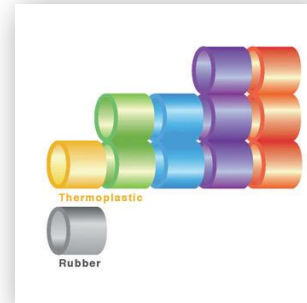

Preforming



- Combining the advantages of bent metal pipe with the flexibility of hose
- Reducing weight, noise and vibration compared to bent metal pipe solutions
- Preformed hoses are maintaining their full technical specifications



Cleanliness



- Less abrasion and contamination inside the hose
- Reduced residue build up
- Extended lifetime for filters, valves and hydraulic systems





Permeation Resistance

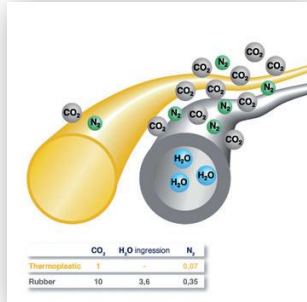

- Low gas permeation
- Reduced ingresson reduced risk of media contamination

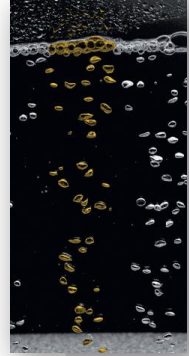

Long Length



- Up to 5,000 m and more continuous length
- Reduced scrap of bulk hose
- Easy winching and handling offer fast deployment of long length

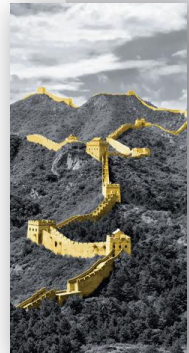

Highest Pressure



- Up to 4,000 bar working pressure
- Highest technical standards and production controls assure safety

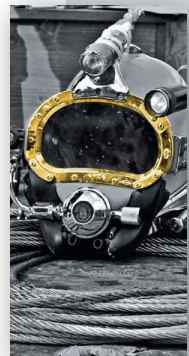

Wide range of applications



- Standard hydraulics
- Industrial hydraulics e.g.
 - alternative energies
 - machine tools
 - injection molding
- Mobile hydraulics e.g.
 - material handling
 - construction
 - agriculture
- Automotive and truck industry
- Mini hydraulics
- Lubrication
- Chemical industry
- Process industry
- Industrial gases
- Alternative fuels
- Boats and yachts
- Pneumatics
- Life Science
- Media transfer
- Sewer Cleaning
- Water jetting
- Water blasting
- Water cutting
- Hydro testing
- Bolt tensioning
- Hydraulic jacking
- Rescue equipment
- Hydraulic control
- Chemical injection
- BOP Control
- Hydraulic lines on Subsea BOPs
- Hot lines from vessel or rig to Subsea BOP
- Hydrostatic testing
- Equipment maintenance
- Well equipment testing
- Cementing operations acc. to API 7K FSL 0
- Acidizing
- General Fluid and Gas Injection
- Mud Circulation
- Jumpers
- Flying Leads
- Electro/Hydraulic Workover
- Pipeline Testing

Value added services

Parker Polyflex and the Parker Sales Companies offer value added services that compliment our production capabilities and product portfolio. These services are in place to meet the increasing customization and system criteria that our customers expect from a world-class supplier. The value added services detailed below are typical of the products and secondary services that we provide to our customers. If you have additional service needs that we have not detailed below please contact us. We are happy to discuss all potential solutions for your requirements.

ParkerStore™

At Parker Hannifin, we're continually looking for ways to deliver more products, more efficiently.

The Global ParkerStore™ network enables Parker to provide:

- Prompt, efficient, professional in-store services while you wait
- Expert local services and support
- A safe, friendly and convenient shopping environment
- A greater range of parts options so you get exactly what you're looking for.



Customers trust ParkerStores to provide OEM and MRO customers with direct access to:

- Custom-made hydraulic hose assemblies and complementary products to support their applications and decrease their downtime
- Expert technical support
- Professional, personalized services, including 24/7/365 support
- The convenience, comfort and amenities of a local service provider.

The Parker® Tracking System Enterprise (PTS)



is designed to help customers reduce vehicle or asset down-time through increases in the speed, timing and accuracy of necessary repairs. PTS provides a unique 8 digit identification code and bar code printed on a durable label for each hose assembly. PTS labels are specifically engineered to withstand harsh chemicals, temperatures, UV exposure and other challenging conditions.

- PTS captures, records and recalls unique hose assembly information – on demand
- Provides fast and accurate product identification to speed up replacement regardless of where the original assembly was made.
- Assembly can be replaced with only the 8 digit PTS ID number/bar code eliminating the need to remove hoses prior to replacement. This can provide critical machine uptime and enable more conveniently scheduled repair.
- PTS includes additional reporting tools to assist in continuous improvement programmes and preventative maintenance initiatives.

Parker HOSE DOCTORS



are a network of independently-owned, mobile service technicians built around the commitment to identify and replace hose assemblies wherever their customers need them, with the fastest response times possible. HOSE DOCTORS® are an extension of the worldwide Parker distribution network, coupling their service commitment with Parker products – the highest quality hoses and fittings available in the market today.

Parker Store Container Service



The ParkerStore container is a transportable workshop, providing on-site maintenance and product support for large construction projects such as roadworks, tunnels, railways, underground systems, etc. Provides an on-site product and hose replacement service. With this service on your site, you can reduce your downtime keeping your project on time and on budget!

Tech Services

Optimises the performance of your hydraulic and pneumatic circuits

- With Parker Tech Services involved, your time to market is shorter, which saves on development costs
- The 3 year no-leak guarantee enhances your reputation and lowers your warranty costs
- More reliable operation lowers your customer's operating costs
- More efficient performance and no-leak guarantee is beneficial to the environment
- Parker worldwide coverage ensures you can use the service and save costs wherever you are



Breadman

Lean logistics and delivery of Parker products and kits directly to the customer's assembly line, work stations or warehouse

- 100 % parts availability minimises downtime, increases production and reduces costs
- Elimination of stock checking reduces manpower and maintains production levels
- Daily delivery reduces inventory and overheads
- Electronic order processing eliminates paperwork and reduces administration costs



Kitting

Multiple components are supplied under a single part number

- Reduced number of suppliers
- Reduced stocks and no obsolete items
- Optimized management (stock and supplies)
- Simplified and optimised order handling
- Reduced assembly costs
- Greater productivity



Hose & Fitting Selection Database

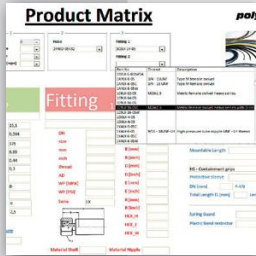

- Always the right hose and fitting combination
- Accessories corresponding to the selected hose
- Frequent updates for new hose-fitting combinations and accessories

Chapter A**General Information**

Hose selection chart by working pressure – design factor >2:1	A-2
Hose selection chart by working pressure – design factor 4:1	A-4
Hose fitting chart.....	A-5

Hose selection chart by working pressure – design factor >2:1





Nominal size				Working pressure MPa [psi]									
				ESH200	ESH250	2240D-TC (HT-TC)	2248D-TC (HT-TC)	2380N	2388N	2580N	2440D 2440N (-06 to -16)	2440D-TC	2448D-TC
DN	size	mm	inch										
3	-02	3.2	1/8			110 [15,950]					210 [30,450]	210 [30,450]	
4	-025	4.0	5/32			120 [17,400]	150 [21,750]	140 [20,300]			220 [31,900]	220 [31,900]	301 [43,640]
5	-03	4.8	3/16			110 [15,950]	140 [20,300]				180 [26,100]	180 [26,100]	
6	-04	6.4	1/4			110 [15,950]		110 [15,950]	128 [18,560]		164 [23,780]	164 [23,780]	
8	-05	7.9	5/16				100 [14,500]	103 [15,000]			150 [21,750]	150 [21,750]	
10	-06	9.5	3/8					92 [13,340]	125 [18,125]	160 [23,200]	140 [20,300]		
12	-08	12.7	1/2	20 [2,900]	25 [3,625]			88 [12,760]	110 [15,950]	140 [20,300]	140 [20,300]		
20	-12	19.0	3/4	20 [2,900]	25 [3,625]					120 [17,400]	100 [14,500]		
25	-16	25.4	1	20 [2,900]	25 [3,625]						90 [31,900]		
32	-20	31.8	1 1/4	20 [2,900]	25 [3,625]								
Fitting series				EH/ES	EH/ES	TX	TX	KY / 8X / LX	KY / BS	BL	LX	LX	LX
Page				C-2	C-4	C-6	C-7	C-13	C-17	C-21	C-24	C-25	C-38

Working pressure MPa [psi]							
2640D 2640N (-08 to -16)	2648N	PFX21 PFX21TJ- 2nd cover	PFX25 PFX25TJ- 2nd cover	PFX30 PFX30TJ- 2nd cover	PFX38 PFX38TJ- 2nd cover	PFX40 PFX40TJ- 2nd cover	
280 [40,600]							
250 [36,250]						400 [58,000]	
250 [36,250]							
			250 [36,250]	301 [43,645]	380 [55,000]		
				301 [43,645]			
180 [26,100]		210 [30,450]		301 [43,645]			
140 [20,300]	160 [23,200]						
120 [17,400]	150 [21,750]						
JX / 2X	JX / CX	2X	2X	2X	2X	2X	
C-40	C-48	C-50	C-53	C-56	C-62	C-65	

Hose selection chart by working pressure – design factor 4:1

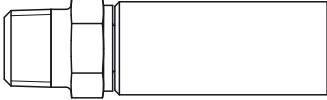
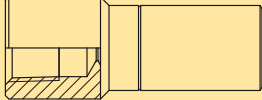
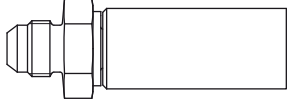
Nominal size				2022N	2244N	2380N	2388N
3	-02	3.2	1/8				
4	-025	4.0	5/32		75 [10,875]	75 [10,875]	
5	-03	4.8	3/16				
6	-04	6.4	1/4	69 [10,000]		70 [10,150]	80 [11,600]
8	-05	7.9	5/16			62.5 [9,060]	
10	-06	9.5	3/8	69 [10,000]	53.5 [7,755]	57.5 [8,337]	72 [10,400]
12	-08	12.7	1/2	69 [10,000]	55 [7,975]	55 [7,975]	
20	-12	19.0	3/4				
25	-16	25.4	1				
32	-20	31.8	1 1/4			27.5 [3,990]	
Fitting series				8X / 3X / LX	8X	8X / LX / NX	8X / BS
Page				B-2	B-5	B-14	B-21

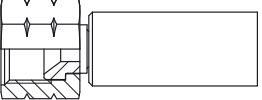
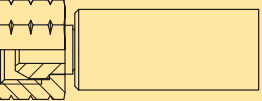
Hose fitting chart

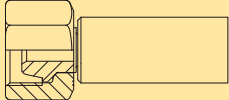
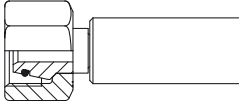
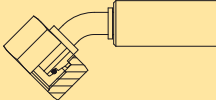
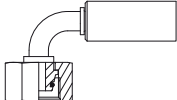
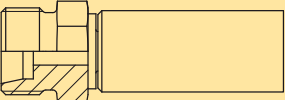
Fitting	Fitting description	Fitting designation
	National Pipe Tapered (NPT) male	01
	National Pipe Tapered (NPT) female	02
	JIC male	03
	UNF male with O-ring	05
	JIC female swivel	06
	NPSM female swivel	07
	Metric female swivel light series	C3
	Metric female swivel heavy series	C6
	Metric female swivel heavy series with O-ring	C9
	Metric female swivel heavy series with O-ring 45° elbow	0C
	Metric female swivel heavy series with O-ring 90° elbow	1C
	Metric male heavy series	D2

Selection

Hose fitting chart

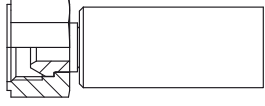
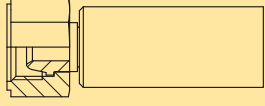
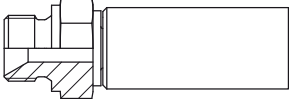
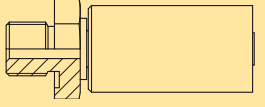
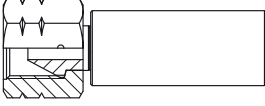
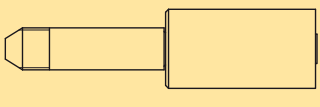
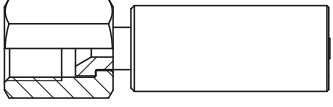
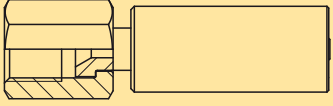
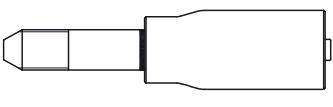
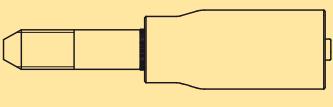
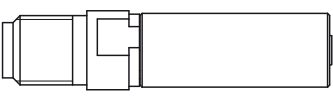
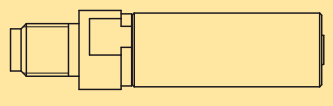
Fitting	Fitting description	Fitting designation
	BSP female swivel (60° cone)	92
	BSP female swivel (ballnose)	U0
	BSP male	D9 or 3B
	BSP male for USIT ring	Y9
	Type "M" female swivel	AY
	Medium pressure tube nipple	Y2
	Medium pressure female swivel	5Y
	High pressure female swivel	6Y
	High pressure tube nipple UNF-LH thread	Y4 or YA
	High pressure tube nipple metric-LH thread	YM
	BSP male nozzle nipple	YB
	Metric male nozzle nipple	YZ

Hose fitting chart

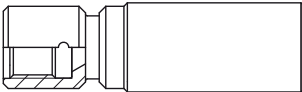
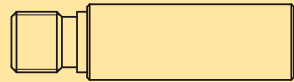
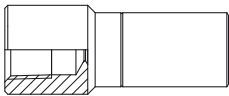
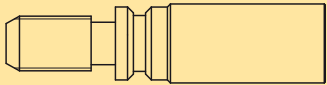
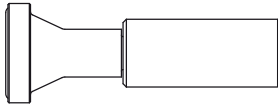
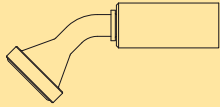
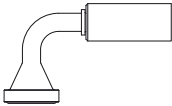
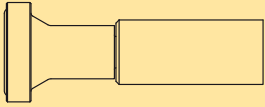
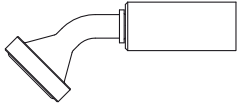
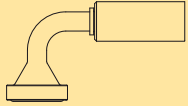
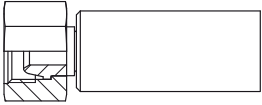
Fitting	Fitting description	Fitting designation
	UNF female for water jetting nozzle (left hand)	HY (-LH)
	Male water jetting nozzle	3Z or ZE
	Female water jetting nozzle	EZ
	UNF male nozzle nipple	YH
	SAE code 61 flange	15
	SAE code 61 flange 45° elbow	17
	SAE code 61 flange 90° elbow	19
	SAE code 62 flange	6A
	SAE code 62 flange 45° elbow	6F
	SAE code 62 flange 90° elbow	6N
	Metric female swivel 59° cone	MR

Chapter B**Hoses with design factor 4:1****Hose**

2022N	– High pressure hose – electrically non-conductive.....	B-2
2244N	– High pressure hose.....	B-5
2380N	– High pressure hose.....	B-14
2388N	– High pressure hose.....	B-21

2022N – High pressure hose electrically non-conductive









Design Factor 4:1

CONSTRUCTION

Core tube : Polyamide 11
 Pressure reinforcement : Two braided layers of high tensile aramid fibre

Cover : Polyurethane
 Standard colour : Orange

TEMPERATURE RANGE -40°C up to +55°C

#													
	DN	size	mm	inch	mm	MPa	psi	MPa	psi	mm	kg/m		
2022N-04V15-10K	6	-04	6.4	1/4	13.8	69	10,000	276	40,000	100	0.14		
2022N-06V15-10K	10	-06	9.7	3/8	19.0	69	10,000	276	40,000	100	0.24		
2022N-08V15-10K	12	-08	12.9	1/2	23.0	69	10,000	276	40,000	100	0.34		

NOTES -

1068X / 1063X / 106LX – JIC female swivel

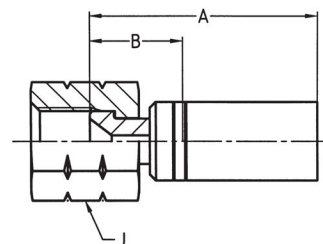

MATERIAL Carbon Steel, zinc plated
C: Stainless steel (AISI 316), other materials on request.

#	⊙				⌚	A	B	H	⊙		Nipple ID	Ferrule OD
	DN	size	mm	inch					MPa	psi		
1068X-4-04	6	-04	6.4	1/4	7/16 - 20 UNF	57	26	19	69.0	10,000	2.8	18.4
1068X-4-04C	6	-04	6.4	1/4	7/16 - 20 UNF	57	26	19	69.0	10,000	2.2	18.4
1068X-5-04	6	-04	6.4	1/4	1/2 - 20 UNF	55	24	19	80.0	11,600	3.6	18.4
1068X-5-04C	6	-04	6.4	1/4	1/2 - 20 UNF	55	24	19	80.0	11,600	3.6	18.4
1068X-6-04	6	-04	6.4	1/4	9/16 - 18 UNF	55	24	19	80.0	11,600	3,8	18,4
1068X-6-04C	6	-04	6.4	1/4	9/16 - 18 UNF	55	24	19	80.0	11,600	3.6	18.4
1063X-6-06C	10	-06	9.5	3/8	9/16 - 18 UNF	69	33	22	69.0	10,000	5.3	23.2
106LX-8-08	12	-08	12.7	1/2	3/4 - 16 UNF	80	27	27	69.0	10,000	6.7	30.7
106LX-8-08C	12	-08	12.7	1/2	3/4 - 16 UNF	80	27	27	69.0	10,000	6.7	30.7

Design Factor 4:1

1928X / 1923X / 192LX – BSP female swivel (60° cone)

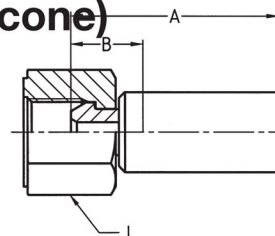

MATERIAL Stainless steel (AISI 316), other materials on request.



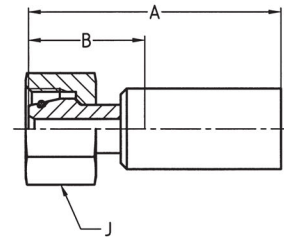

#	⊙				⌚	A	B	J	⊙		Nipple ID	Ferrule OD
	DN	size	mm	inch					MPa	psi		
1928X-4-04	6	-4	6,4	1/4	G 1/4	56	25	19	80	11600	3,8	18,4
1928X-4-04C	6	-4	6,4	1/4	G 1/4	56	25	19	80	11600	3,8	18,4
1923X-8-06C	10	-06	9.5	3/8	G 1/2	66	22	30	69	10,000	5.3	23.2
192LX-8-08	12	-08	12.7	1/2	G 1/2	75	21	30	130	18,850	6.7	30.7
192LX-8-08C	12	-08	12.7	1/2	G 1/2	75	21	30	130	18,850	6.7	30.7

1C98X / 1C93X / 1C9LX – Metric female swivel Heavy series



Design Factor 4:1



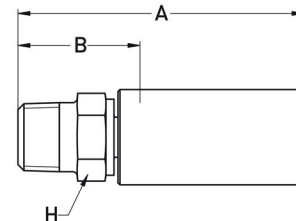

MATERIAL Stainless steel (AISI 316), other materials on request.

#						A	B				Nipple ID	Ferrule OD
	DN	size	mm	inch					mm	mm		
1C98X-6-04	6	-4	6,4	1/4	M14x1.5	60,9	33	17	80	11600	3,8	18,4
1C98X-8-04	6	-4	6,4	1/4	M16x1.5	59	27	19	80	11600	3,8	18,4
1C98X-8-04C	6	-04	6.4	1/4	M16 x 1.5	59	27	19	69.0	10,000	3.6	18.4
1C98X-10-04	6	-4	6,4	1/4	M18x1.5	56	33	22	80	11600	3,8	18,4
1C98X-10-04C	6	-04	6.4	1/4	M18 x 1.5	65	33	22	69.0	10,000	3.6	18.4
1C98X-12-04	6	-4	6,4	1/4	M20x1.5	69	37	24	80	11600	3,8	18,4
1C93X-14-06C	10	-06	9.5	3/8	M22 x 1.5	75	30	30	69.0	10,000	5.3	23.2
1C93X-16-06C	10	-06	9.5	3/8	M24 x 1.5	88	34	30	69.0	10,000	5.3	23.2
1C9LX-16-08	12	-08	12.7	1/2	M24 x 1.5	88	34	30	130.0	18,850	6.6	30.0
1C9LX-16-08C	12	-08	12.7	1/2	M24 x 1.5	88	34	30	130.0	18,850	6.6	30.0

1018X / 101LX – National Pipe Tapered (NPT) male



MATERIAL Carbon steel, zinc plated, C: Stainless steel

#						A	B				Nipple ID	Ferrule OD
	DN	size	mm	inch					mm	mm		
1018X-4-04	6	-4	6,4	1/4	1/4 - 18 NPTF	65	33	14	103,4	15000	3,8	18,4
1018X-4-04C	6	-4	6,4	1/4	1/4 - 18 NPTF	65	33	14	103,4	15000	3,8	18,4
1018X-6-04	6	-4	6,4	1/4	3/8 - 18 NPTF	67	35	19	103,4	15000	3,8	18,4
1018X-6-04C	12	-8	12,7	1/2	1/2 - 14 NPTF	91	37	22	103,4	15000	7	30,5
1013X-6-06C	12	-8	12,7	1/2	1/2 - 14 NPTF	91	37	22	103,4	15000	7	30,5
101LX-8-08	6	-4	6,4	1/4	3/8 - 18 NPTF	68	35	19	103,4	15000	3,8	18,4
101LX-8-08C	10	-6	9,8	3/8	3/8 - 18 NPTF	76	31	19	103,4	15000	6	23,2

2244N – High pressure hose









CONSTRUCTION

- Core tube** : Polyamide
- Pressure reinforcement** : Two spiral layers, one braided layer of high tensile steel wire
- Cover** : Polyurethane
- Standard colour** : Black

TEMPERATURE RANGE -40°C up to +100°C

Design Factor 4:1

#													
	DN	size	mm	inch	mm	MPa	psi	MPa	psi	mm	kg/m		
2244N-025V00	4	-025	3.9	5/32	9.6	75.0	10,875	300	43,500	55	0.19		
2244N-06V00	10	-06	9.8	3/8	18.0	53.5	7,755	215	31,175	120	0.50		
2244N-08V10	12	-08	12.9	1/2	22.7	55.0	7,975	220	31,900	150	0.80		

NOTES - 2244N with DNV approval



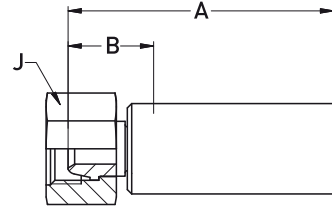

Hoses with design factor 4:1
 1C38X

1C38X – Metric female swivel light series



Design Factor 4:1



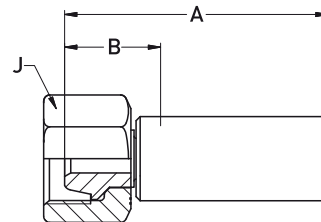

MATERIAL Carbon steel, zinc plated

#						A	B				Nipple ID	Ferrule OD
	DN	size	mm	inch		mm	mm	mm	MPa	psi	mm	mm
1C38X-12-06	10	-06	9.5	3/8	M18x1.5	48	19	22	57.5	8,340	6.8	23.8
1C38X-15-08	12	-08	12.7	1/2	M22x1.5	51	20	27	55.0	7,975	8.8	29.5

1C68X – Metric female swivel heavy series



MATERIAL Carbon steel, zinc plated



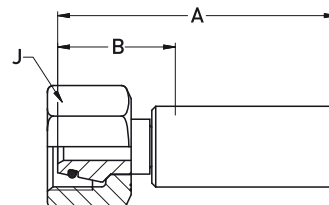

#						A	B			Nipple ID	Ferrule OD	
	DN	size	mm	inch								mm
1C68X-16-08	12	-08	12.7	1/2	M24x1.5	67	24	30	55.0	7,975	8.8	29.5

Design Factor 4:1

1C98X – Metric female swivel heavy series with O-ring ISO 12151-2



MATERIAL Carbon steel, zinc plated

#						A	B			Nipple ID	Ferrule OD	
	DN	size	mm	inch								mm
1C98X-8-025	4	-025	4	5/32	M16x1.5	54	27	19	75.0	10,875	2.3	13.2
1C98X-8-025C	4	-025	4	5/32	M16x1.5	54	27	19	75	10875	2,5	13
1C98X-12-06	10	-06	9.5	3/8	M20x1.5	70	30	24	63.0	9,135	6.8	23.8
1C98X-12-06C	10	-6	9,5	3/8	M20x1.5	70	30	24	63	9135	7	23,8
1C98X-14-06	10	-06	9.5	3/8	M22x1.5	71	30	27	63.0	9,135	6.8	23.8
1C98X-14-06C	10	-6	9,5	3/8	M22x1.5	70	30	27	63	9135	7	23,8
1C98X-16-08	12	-08	12.7	1/2	M24x1.5	78	35	30	63.0	9,135	8.8	29.5
1C98X-16-08C	12	-8	12,8	1/2	M24x1.5	77,5	34	30	63	9135	8,8	29,5

Hoses with design factor 4:1
 10C8X – 11C8X



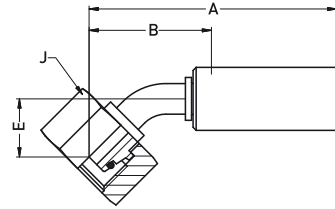

10C8X – Metric female swivel heavy series with O-ring, 45° elbow

ISO 12151-2

MATERIAL Carbon steel, zinc plated



Design Factor 4:1





#						A	B	E				Nipple ID	Ferrule OD
	DN	size	mm	inch						mm	mm		
10C8X-12-06	10	-06	9.5	3/8	M20x1.5	81	40	19	24	63.0	9,135	6.8	23.8
10C8X-14-06	10	-06	9.5	3/8	M22x1.5	81	40	19	27	63.0	9,135	6.8	23.8
10C8X-16-08	12	-08	12.7	1/2	M24x1.5	96	53	23	30	63.0	9,135	8.8	29.5

11C8X – Metric female swivel heavy series with O-ring, 90° elbow

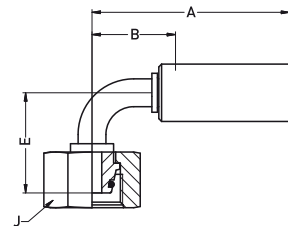
ISO 12151-2

MATERIAL Carbon steel, zinc plated



#						A	B	E				Nipple ID	Ferrule OD
	DN	size	mm	inch						mm	mm		
11C8X-14-06	10	-06	9.5	3/8	M22x1.5	71	30	36	27	63.0	9,135	6.8	23.8
11C8X-16-08	12	-08	12.7	1/2	M24x1.5	85	42	44	30	63.0	9,135	8.8	29.5

1D28X – Metric male heavy series
 ISO 12151-2

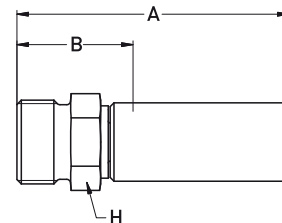

MATERIAL Carbon steel, zinc plated

#	⊙				⌚	A	B	H	↻		Nipple ID	Ferrule OD
	DN	size	mm	inch					MPa	psi		
1D28X-14-06	10	-06	9.5	3/8	M22x1.5	71	31	22	63.0	9,135	6.8	23.8
1D28X-16-08	12	-08	12.7	1/2	M24x1.5	74	31	24	63.0	9,135	8.8	29.5

Design Factor 4:1

1928X – BSP female swivel (60° cone)

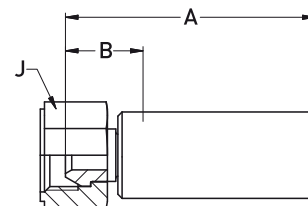

MATERIAL Carbon steel, zinc plated

#	⊙				⌚	A	B	J	↻		Nipple ID	Ferrule OD
	DN	size	mm	inch					MPa	psi		
1928X-4-025	4	-025	4.0	5/32	G 1/4	48	20	19	75.0	10,875	2.3	13.2
1928X-6-06	10	-06	9.5	3/8	G 3/8	59	19	22	57.5	8,340	6.8	23.8
1928X-6-06C	10	-6	9,5	3/8	G 3/8	59	19	22	69	10000	7	23,8
1928X-8-06	10	-06	9.5	3/8	G 1/2	60	20	27	57.5	8,340	6.8	23.8
1928X-8-06C	10	-6	9,5	3/8	G 1/2	60	20	27	57,5	8340	7	23,8
1928X-8-08	12	-08	12.7	1/2	G 1/2	63	20	27	55.0	7,975	8.8	29.5
1928X-8-08C	12	-8	12,8	1/2	G 1/2	63	20	27	55	7975	8,8	29,5



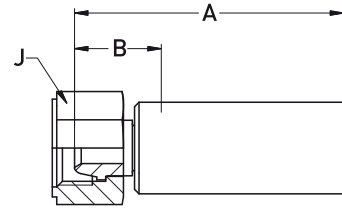

Hoses with design factor 4:1
 1U08X

1U08X – BSP female swivel (ballnose)



Design Factor 4:1

MATERIAL Carbon steel, zinc plated

#						A	B				Nipple ID	Ferrule OD
	DN	size	mm	inch		mm	mm	mm	MPa	psi		
1U08X-6-06	10	-06	9.5	3/8	G 3/8	61	20	22	57.5	8,340	6.8	23.8
1U08X-8-06	10	-06	9.5	3/8	G 1/2	61	20	27	53.5	7,755	6.8	23.8
1U08X-8-08	12	-08	12.7	1/2	G1/2	61	22	27	55.0	7,975	6.8	23.8

13B8X – BSP male

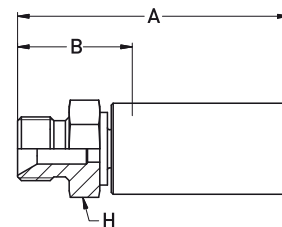

MATERIAL Carbon steel, zinc plated

Design Factor 4:1

#	⊙				⌚	A	B	H	⊙		Nipple ID	Ferrule OD
	DN	size	mm	inch					MPa	psi		
13B8X-4-025	4	-025	4.0	5/32	G 1/4	57	30	17	75.0	10,875	2.3	13.2
13B8X-6-06	10	-06	9.5	3/8	G 3/8	71	30	22	57.5	8,340	6.8	23.8
13B8X-6-06C	10	-6	9,5	3/8	3/8 - 18 NPTF	71	31	19	103,4	15000	7	23,8
13B8X-8-06	10	-06	9.5	3/8	G 1/2	76	35	22	57.5	8,340	6.8	23.8
13B8X-8-06C	10	-6	9,5	3/8	1/2 - 14 NPTF	76	36	22	103,4	15000	7	23,8
13B8X-8-08	12	-08	12.7	1/2	G 1/2	79	35	24	55.0	7,974	8.8	29.5
13B8X-8-08C	12	-8	12,8	1/2	1/2 - 14 NPTF	79	36	22	103,4	15000	8,8	29,5

1018X – NPT male

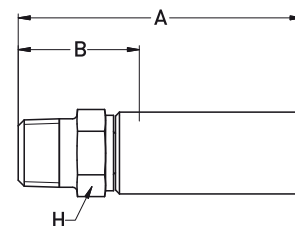

MATERIAL Carbon steel, zinc plated



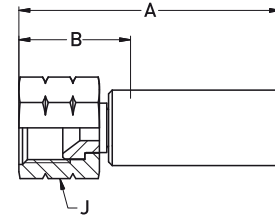

#	⊙				⌚	A	B	H	⊙		Nipple ID	Ferrule OD
	DN	size	mm	inch					MPa	psi		
1018X-2-025	4	-025	4.0	5/32	1/8 NPT	51	24	8	75.0	10,875	2.3	13.2
1018X-4-025	4	-025	4.0	5/32	1/4 NPT	59	32	13	75.0	10,875	2.3	13.2
1018X-6-06	10	-06	9.5	3/8	3/8 NPT	71	31	19	103.4	15,000	6.8	23.8
1018X-6-06C	10	-6	9,5	3/8	3/8 - 18 NPTF	71	31	19	103,4	15000	7	23,8
1018X-8-06	10	-06	9.5	3/8	1/2 NPT	76	36	22	103.4	15,000	6.8	23.8
1018X-8-06C	10	-6	9,5	3/8	1/2 - 14 NPTF	76	36	22	103,4	15000	7	23,8
1018X-8-08	12	-08	12.7	1/2	1/2 NPT	79	37	22	103.4	15,000	8.8	29.5
1018X-8-08C	12	-8	12,8	1/2	1/2 - 14 NPTF	79	36	22	103,4	15000	8,8	29,5

1068X – JIC female swivel



Design Factor 4:1



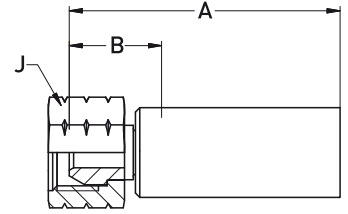

MATERIAL Carbon steel, zinc plated, C: Stainless steel

#						A	B				Nipple ID mm	Ferrule OD mm
	DN	size	mm	inch		mm	mm	mm	MPa	psi		
1068X-6-06	10	-06	9.5	3/8	9/16 - 18 UNF	59	18	22	69	10,000	6.8	23.8
1068X-6-06C	10	-06	9.5	3/8	9/16 - 18 UNF	59	18	22	69	10,000	6.8	23.8
1068X-8-06	10	-06	9.5	3/8	3/4 - 16 UNF	59	19	24	69	10,000	6.8	23.8
1068X-8-06C	10	-6	9,5	3/8	3/4 - 16 UNF	69,5	30,5	24	69	10000	7	23,8
1068X-8-08	12	-08	12.7	1/2	3/4 - 16 UNF	64	21	27	69	10,000	8.8	29.5
1068X-8-08C	12	-08	12.7	1/2	3/4 - 16 UNF	64	21	27	69	10,000	8.8	29.5
1068X-10-08	12	-08	12.7	1/2	7/8 - 14 UNF	62	19	27	69	10,000	8.8	29.5
1068X-10-08C	12	-8	12,8	1/2	7/8 - 14 UNF	75	32	27	55	7975	8,8	29,5

1078X – NPSM female swivel



MATERIAL Carbon steel, zinc plated, C: Stainless steel

#						A	B			Nipple		Ferrule
	DN	size	mm	inch		mm	mm	mm		MPa	psi	ID
1078X-6-06	10	-06	9.5	3/8	3/8 - 18NPSM	50	21	22	57.5	8,340	6.8	23.8
1078X-8-08	12	-08	12.7	1/2	1/2 - 14NPSM	50	19	27	55.0	7,975	8.8	29.5

Design Factor 4:1

2380N – High pressure hose









Design Factor 4:1

CONSTRUCTION

- Core tube** : Polyamide
- Pressure reinforcement** : Two spiral layers and two open spiral layers of high tensile steel wire
- Cover** : Polyurethane, DN32: Polyamide
- Standard colour** : Black

TEMPERATURE RANGE -40°C up to +100°C

#												
	DN	size	mm	inch	mm	MPa	psi	MPa	psi	mm	kg/m	
2380N-025V10	4	-025	3.9	5/32	9.7	75.0	10,875	300	43,500	55	0.16	
2380N-04V00	6	-04	6.3	1/4	13.4	70.0	10,150	280	40,600	70	0.27	
2380N-05V00	8	-05	8.3	5/16	15.8	62.5	9,060	250	36,250	90	0.35	
2380N-06V10	10	-06	9.8	3/8	17.9	57.5	8,337	230	33,350	120	0.44	
2380N-08V10	12	-08	12.9	1/2	22.9	55.0	7,975	220	31,900	150	0.68	
2380N-20V30	32	-20	31.8	1 1/4	44.0	27.5	3,985	110	15,950	400	1.83	

NOTES -

**1018X / 101LX – National Pipe Tapered (NPT)
 male**

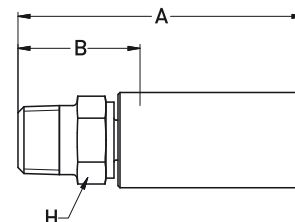

MATERIAL Carbon steel, zinc plated, C: Stainless steel

Design Factor 4:1

#						A	B				Nipple ID	Ferrule OD
	DN	size	mm	inch					MPa	psi		
1018X-2-025	4	-025	4.0	5/32	1/8 NPT	51	24	8	75.0	10,875	2.3	13.2
1018X-4-025	4	-025	4.0	5/32	1/4 NPT	59	32	13	75.0	10,875	2.3	13.2
1018X-1-04	6	-04	6.4	1/4	1/16 NPT	59	27	14	103.4	15,000	3.6	18.5
1018X-2-04	6	-04	6.4	1/4	1/8 NPT	60	28	13	103.4	15,000	3.6	18.5
1018X-4-04	6	-04	6.4	1/4	1/4 NPT	65	33	14	103.4	15,000	3.6	18.5
1018X-4-04C	6	-04	6.4	1/4	1/4 NPT	65	33	14	103.4	15,000	3.6	18.5
1018X-6-04	6	-04	6.4	1/4	3/8 NPT	67	35	19	103.4	15,000	3.6	18.5
1018X-6-04C	6	-04	6.4	1/4	3/8 NPT	67	35	19	103.4	15,000	3.6	18.5
1018X-6-05	8	-05	7.9	5/16	3/8 NPT	70	30	19	103.4	15,000	4.8	20.1
1018X-6-05C	8	-05	7.9	5/16	3/8 NPT	70	30	19	103.4	15,000	4.8	20.1
1018X-6-06	10	-06	9.5	3/8	3/8 NPT	71	31	19	103.4	15,000	6.8	23.4
1018X-6-06C	10	-06	9.5	3/8	3/8 NPT	71	31	19	103.4	15,000	6.8	23.4
1018X-8-06	10	-06	9.5	3/8	1/2 NPT	76	36	22	103.4	15,000	6.8	23.4
1018X-8-06C	10	-06	9.5	3/8	1/2 NPT	76	36	22	103.4	15,000	6.8	23.4
101LX-8-08	12	-08	12.7	1/2	1/2 NPT	91	37	22	103.4	15,000	6.7	30.7
101LX-8-08C	12	-08	12.7	1/2	1/2 NPT	91	37	22	103.4	15,000	6.7	30.7

1058X – UNF male with O-ring

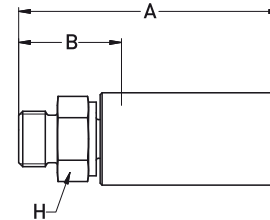

Design Factor 4:1

MATERIAL Special materials

#						A	B				Nipple ID	Ferrule OD
	DN	size	mm	inch					MPa	psi		
1058X-4-04	6	-04	6.4	1/4	7/16 - 20 UNF	61	29	14	80	11,600	3.6	18.5
1058X-6-04	6	-04	6.4	1/4	9/16 - 18 UNF	62	30	17	80	11,600	3.6	18.5

1068X / 106LX / 106NX – JIC female swivel

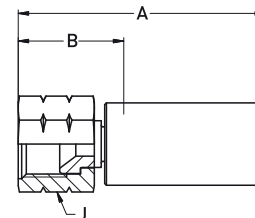

MATERIAL Carbon steel, zinc plated, C: Stainless steel

#						A	B				Nipple ID	Ferrule OD
	DN	size	mm	inch					MPa	psi		
1068X-4-04	6	-04	6.4	1/4	7/16 - 20 UNF	57	26	19	69.0	10,000	2.8	18.5
1068X-4-04C	6	-04	6.4	1/4	7/16 - 20 UNF	57	26	19	69.0	10,000	2.8	18.5
1068X-5-04	6	-04	6.4	1/4	1/2 - 20 UNF	55	24	19	80.0	11,600	2.8	18.5
1068X-5-04C	6	-04	6.4	1/4	1/2 - 20 UNF	55	24	19	80.0	11,600	2.8	18.5
1068X-6-04	6	-04	6.4	1/4	9/16 - 18 UNF	55	24	19	80.0	11,600	3.6	18.5
1068X-6-04C	6	-04	6.4	1/4	9/16 - 18 UNF	55	24	19	80.0	11,600	3.6	18.5
1068X-6-05	8	-05	7.9	5/16	9/16 - 18 UNF	56	16	19	69.0	10,000	4.8	20.1
1068X-6-05C	8	-05	7.9	5/16	9/16 - 18 UNF	56	16	19	69.0	10,000	4.8	20.1
1068X-6-06	10	-06	9.5	3/8	9/16 - 18 UNF	59	18	22	69.0	10,000	4.8	23.4
1068X-6-06C	10	-06	9.5	3/8	9/16 - 18 UNF	59	18	22	69.0	10,000	4.8	23.4
106LX-8-08	12	-08	12.7	1/2	3/4 - 16 UNF	80	27	27	69.0	10,000	6.7	30.7
106LX-8-08C	12	-08	12.7	1/2	3/4 - 16 UNF	80	27	27	69.0	10,000	6.7	30.7
106NX-20-20	32	-20	31,8	1 1/4	1 5/8 - 12 UN	97,5	44,5	50	27,5	3985	25,5	49,4

1928X / 192LX / 192NX – BSP female swivel (60° cone)

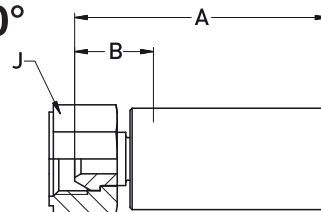

MATERIAL Carbon steel, zinc plated, C: Stainless steel

Design Factor 4:1

#						A	B			Nipple ID	Ferrule OD	
	DN	size	mm	inch								mm
1928X-4-025	4	-025	4.0	5/32	G 1/4	48	20	19	75.0	10,875	2.3	13.2
1928X-4-04	6	-04	6.4	1/4	G 1/4	56	25	19	80.0	11,600	3.6	18.5
1928X-4-04C	6	-04	6.4	1/4	G 1/4	56	25	19	80.0	11,600	3.6	18.5
1928X-6-06	10	-06	9.5	3/8	G 3/8	59	19	22	57.5	8,340	6.8	23.4
1928X-6-06C	10	-06	9.5	3/8	G 3/8	59	19	22	57.5	8,340	6.8	23.4
1928X-8-06	10	-06	9.5	3/8	G 1/2	60	20	27	57.5	8,340	6.8	23.4
1928X-8-06C	10	-06	9.5	3/8	G 1/2	60	20	27	57.5	8,340	6.8	23.4
192LX-8-08	12	-08	12.7	1/2	G 1/2	75	21	30	130.0	18,850	6.7	30.7
192LX-8-08C	12	-08	12.7	1/2	G 1/2	75	21	30	130.0	18,850	6.7	30.7
192NX-24-20C	32	-20	31,8	1 1/4	G 1 1/2	91	30	55	27,5	3985	25,5	49,4

1D98X / 1D9LX – BSP male

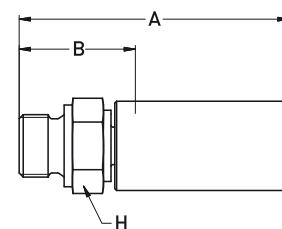

MATERIAL Carbon steel, zinc plated, C: Stainless steel



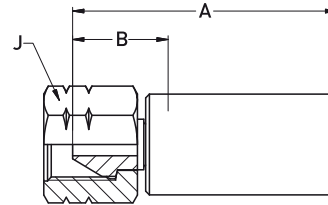

#						A	B			Nipple ID	Ferrule OD	
	DN	size	mm	inch								mm
1D98X-4-025	4	-025	4.0	5/32	G 1/4	60	33	19	75.0	10,875	2.3	13.2
1D98X-4-04	6	-04	6.4	1/4	G 1/4	67	35	19	80.0	11,600	3.6	18.5
1D98X-4-04C	6	-04	6.4	1/4	G 1/4	67	35	19	80.0	11,600	3.6	18.5
1D98X-6-04	6	-04	6.4	1/4	G 3/8	69	37	22	80.0	11,600	3.6	18.5
1D98X-6-06	10	-06	9.5	3/8	G 3/8	70	30	22	57,5	8,340	6.8	23.4
1D9LX-8-08	12	-08	12.7	1/2	G 1/2	88	34	27	130.0	18,850	6.7	30.7

1AY8X – Type “M” female swivel



Design Factor 4:1

MATERIAL Carbon steel, zinc plated



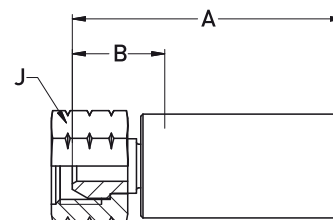

#						A	B				Nipple ID	Ferrule OD
	DN	size	mm	inch		mm	mm	mm	MPa	psi	mm	mm
1AY8X-6-04	6	-04	6.4	1/4	9/16 - 18 UNF	60	28	19	80.0	11,600	3.6	18.5

1078X – NPSM female swivel



MATERIAL Carbon steel, zinc plated

NOTE C2W: Stainless steel nipple

#						A	B				Nipple ID	Ferrule OD
	DN	size	mm	inch		mm	mm	mm	MPa	psi	mm	mm
1078X-4-04	6	-04	6.4	1/4	1/4 - 18NPSM	59	28	19	80.0	11,600	3.6	18.5
1078X-4-04C	6	-4	6,4	1/4	1/4 - 18 NPSM	60	27	19	80	11600	3,8	18,4
1078X-6-04	6	-4	6,4	1/4	3/8 - 18 NPSM	57	24	22	62,5	9060	3,8	18,4
1078X-6-06	10	-06	9.5	3/8	3/8 - 18NPSM	62	21	22	57.5	8,340	6.8	23.4

1U08X – 1U0NX BSP female swivel (ballnose)

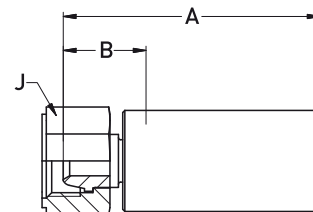

MATERIAL Carbon steel, zinc plated

NOTE C2W: Stainless steel nipple

#						A	B			Nipple ID	Ferrule OD	
	DN	size	mm	inch								mm
1U08X-4-04	6	-04	6.4	1/4	G 1/4	58	27	19	80.0	11,600	3.6	18.5
1U08X-6-04	6	-04	6.4	1/4	G 3/8	58	27	27	80.0	11,600	3.6	18.5
1U08X-6-05	8	-05	7.9	5/16	G 3/8	59	19	19	62.5	9,060	4.8	20.1
1U08X-6-06	10	-06	9.5	3/8	G 3/8	61	20	22	57.5	8,340	6.8	23.4
1U08X-8-06	10	-06	9.5	3/8	G 1/2	61	20	27	57.5	8,340	6.8	23.4
1U0NX-24-20	32	-20	31,8	1 1/4	G 1 1/2	91	37	55	27,5	3985	25,5	49,4

Design Factor 4:1

13B8X / 13BNX – BSP male

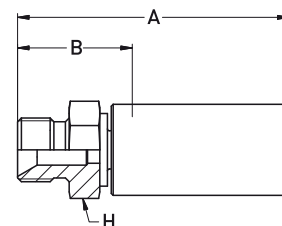

MATERIAL Carbon steel, zinc plated



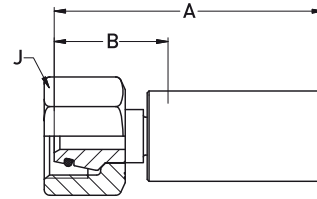

#						A	B			Nipple ID	Ferrule OD	
	DN	size	mm	inch								mm
13B8X-4-025	4	-025	4.0	5/32	G 1/4	57	30	17	75.0	10,875	2.3	13.2
13B8X-4-04	6	-04	6.4	1/4	G 1/4	64	32	17	80.0	11,600	3.6	18.5
13B8X-6-04	6	-04	6.4	1/4	G 3/8	67	35	19	80.0	11,600	3.6	18.5
13B8X-6-05	8	-05	7.9	5/16	G 3/8	69	30	22	62.5	9,060	4.8	20.1
13B8X-6-06	10	-06	9.5	3/8	G 3/8	70	30	22	57.5	8,340	6.8	23.4
13B8X-8-06	10	-06	9.5	3/8	G 1/2	75	35	22	57.5	8,340	6.8	23.4
13BNX-24-20	32	-20	31.8	1 1/4	G 1 1/2	118	57	55	27.5	3,990	24.9	49.4

1C98X / 1C9LX / 1C9NX – Metric female swivel heavy series with O-ring



Design Factor 4:1

MATERIAL Carbon steel, zinc plated, C: Stainless steel

#						A	B				Nipple ID	Ferrule OD
	DN	size	mm	inch					mm	mm		
1C98X-6-04	6	-4	6,4	1/4	M14x1.5	60,9	33	17	70	10150	3,8	18,4
1C98X-8-025	4	-025	4.0	5/32	M16x1.5	54	27	19	75.0	10,875	2.3	13.2
1C98X-8-025C	4	-025	4.0	5/32	M16x1.5	54	27	19	75.0	10,875	2.3	13.2
1C98X-8-04	6	-04	6.4	1/4	M16x1.5	59	27	19	80.0	11,600	3.6	18.5
1C98X-8-04C	6	-04	6.4	1/4	M16x1.5	59	27	19	80.0	11,600	3.6	18.5
1C98X-10-04	6	-04	6.4	1/4	M18x1.5	56	33	22	80.0	11,600	3.6	18.5
1C98X-10-04C	6	-04	6.4	1/4	M18x1.5	56	33	22	80.0	11,600	3.6	18.5
1C98X-12-04	6	-04	6.4	1/4	M20x1.5	69	37	24	80.0	11,600	3.6	18.5
1C98X-12-05	8	-05	7.9	5/16	M20x1.5	62	23	24	63.0	9,135	4.8	20.1
1C98X-12-05C	8	-5	7,9	5/16	M20 x 1.5	62	23	24	100	14500	5	20,1
1C98X-16-05	8	-05	7.9	5/16	M24x1.5	65	25	30	63.0	9,135	4.8	20.1
1C98X-12-06	10	-06	9.5	3/8	M20x1.5	70	30	24	63.0	9,135	6.8	23.4
1C98X-12-06C	10	-06	9.5	3/8	M20x1.5	70	30	24	63.0	9,135	6.8	23.4
1C98X-14-06	10	-06	9.5	3/8	M22x1.5	70	30	27	63.0	9,135	6.8	23.4
1C98X-14-06C	10	-06	9.5	3/8	M22x1.5	70	30	27	63.0	9,135	6.8	23.4
1C9LX-16-08	12	-08	12.7	1/2	M24x1.5	88	34	30	130.0	18,850	6.6	30.0
1C9LX-16-08C	12	-8	12,7	1/2	M24x1.5	88	34	30	130	18850	7	30,5
1C9NX-38-20	32	-20	31.8	1 1/4	M52x2	113	52	60	44.0	6,380	24.9	49.4
1C9NX-38-20C	12	-8	12,7	1/2	M24x1.5	88	34	30	130	18850	25,5	49,4

2388N – High pressure hose







CONSTRUCTION

Core tube : Polyamide
Pressure reinforcement : Two spiral layers and two open spiral layers of high tensile steel wire
Cover : Polyurethane
Standard colour : V00: Black; V12: Blue

TEMPERATURE RANGE

-40°C up to +100°C

Design Factor 4:1

#												
	DN	size	mm	inch	mm	MPa	psi	MPa	psi	mm	kg/m	
2388N-04V00	6	-04	6.3	1/4	13.4	80	11,600	320	46400	80	0.30	
2388N-06V12	10	-06	10,1	3/8	19,8	72	10440	288	41760	100	0,65	

NOTES -

Hoses with design factor 4:1
1018X – 1058X

1018X – National Pipe Tapered (NPT) male

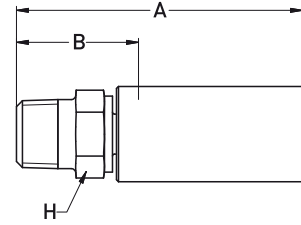

MATERIAL Carbon steel, zinc plated, C: Stainless steel

Design Factor 4:1

#						A	B				Nipple ID	Ferrule OD
	DN	size	mm	inch					MPa	psi		
1018X-1-04	6	-04	6.4	1/4	1/16 NPT	59	27	14	103.4	15,000	3.6	18.3
1018X-2-04	6	-04	6.4	1/4	1/8 NPT	60	28	13	103.4	15,000	3.6	18.3
1018X-4-04	6	-04	6.4	1/4	1/4 NPT	65	33	14	103.4	15,000	3.6	18.3
1018X-4-04C	6	-04	6.4	1/4	1/4 NPT	65	33	14	103.4	15,000	3.6	18.3
1018X-6-04	6	-04	6.4	1/4	3/8 NPT	67	35	19	103.4	15,000	3.6	18.3
1018X-6-04C	6	-04	6.4	1/4	3/8 NPT	67	35	19	103.4	15,000	3.6	18.3

1058X – UNF male with O-ring

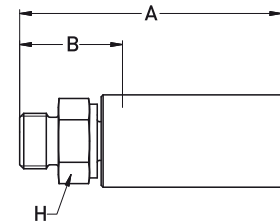

MATERIAL Special materials

#						A	B				Nipple ID	Ferrule OD
	DN	size	mm	inch					MPa	psi		
1058X-4-04	6	-04	6.4	1/4	7/16 - 20 UNF	61	29	14	80	11,600	3.6	18.3
1058X-6-04	6	-04	6.4	1/4	9/16 - 18 UNF	62	30	17	80	11,600	3.6	18.3

1068X – JIC female swivel

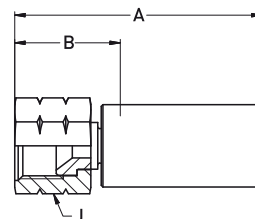

MATERIAL Carbon steel, zinc plated, C: Stainless steel

#						A	B			Nipple ID	Ferrule OD	
	DN	size	mm	inch								mm
1068X-4-04	6	-04	6.4	1/4	7/16 - 20 UNF	57	26	19	69.0	10,000	2.8	18.3
1068X-4-04C	6	-04	6.4	1/4	7/16 - 20 UNF	57	26	19	69.0	10,000	2.8	18.3
1068X-5-04	6	-04	6.4	1/4	1/2 - 20 UNF	55	24	19	80.0	11,600	3.6	18.3
1068X-5-04C	6	-04	6.4	1/4	1/2 - 20 UNF	55	24	19	80.0	11,600	3.6	18.3
1068X-6-04	6	-04	6.4	1/4	9/16 - 18 UNF	55	24	19	80.0	11,600	3.6	18.3
1068X-6-04C	6	-04	6.4	1/4	9/16 - 18 UNF	55	24	19	80.0	11,600	3.6	18.3

Design Factor 4:1

1928X / 192BS – BSP female swivel (60° cone)

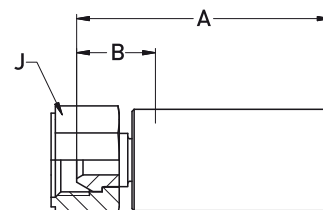

MATERIAL Carbon steel, zinc plated, C: Stainless steel

#						A	B			Nipple ID	Ferrule OD	
	DN	size	mm	inch								mm
1928X-4-04	6	-04	6.4	1/4	G 1/4	56	25	19	80.0	11,600	3.6	18.3
1928X-4-04C	6	-04	6.4	1/4	G 1/4	56	25	19	80.0	11,600	3.6	18.3
192BS-6-06	10	-6	10	3/8	G 3/8	68,4	22,9	22	150	21750	6	23,5
192BS-8-06	10	-6	10	3/8	G 1/2	67	21,5	30	140	20300	6	23,5



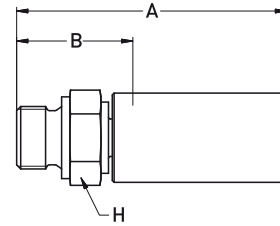

Hoses with design factor 4:1
1D98X – 1AY8X

1D98X – BSP male



MATERIAL Carbon steel, zinc plated, C: Stainless steel



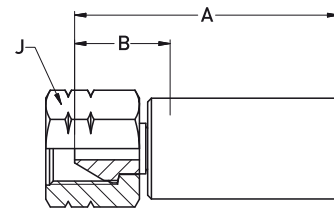

Design Factor 4:1

#						A	B				Nipple ID	Ferrule OD
	DN	size	mm	inch		mm	mm	mm	MPa	psi	mm	mm
1D98X-4-04	6	-04	6.4	1/4	G 1/4	67	35	19	80.0	11,600	3.6	18.3
1D98X-4-04C	6	-04	6.4	1/4	G 1/4	67	35	19	80.0	11,600	3.6	18.3

1AY8X – Type “M” female swivel



MATERIAL Carbon steel, zinc plated



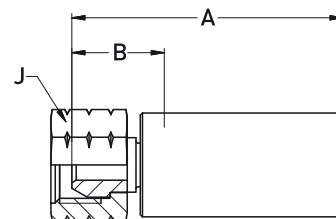

#						A	B				Nipple ID	Ferrule OD
	DN	size	mm	inch		mm	mm	mm	MPa	psi	mm	mm
1AY8X-6-04	6	-04	6.4	1/4	9/16 - 18 UNF	60	28	19	80.0	11,600	3.6	18.3
1AYBS-8-06	10	-6	10	3/8	3/4 - 16 UNF	71	25,5	27	150	21750	6	23,5

1078X – NPSM female swivel



MATERIAL Carbon steel, zinc plated

NOTE C2W: Stainless steel nipple

#						A	B			Nipple ID	Ferrule OD	
	DN	size	mm	inch								mm
1078X-4-04	6	-04	6.4	1/4	1/4 - 18NPSM	59	28	19	80.0	11,600	3.6	18.3



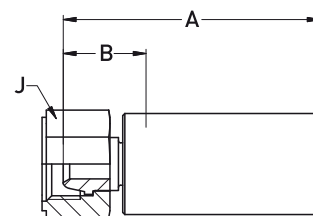

Design Factor 4:1

1U08X – BSP female swivel (ballnose)



MATERIAL Carbon steel, zinc plated

NOTE C2W: Stainless steel nipple



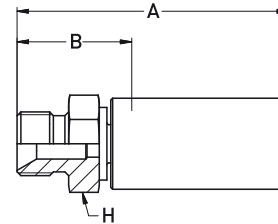

#						A	B			Nipple ID	Ferrule OD	
	DN	size	mm	inch								mm
1U08X-4-04	6	-04	6.4	1/4	G 1/4	58	27	19	80.0	11,600	3.6	18.3
1U08X-4-04C2W	6	-04	6.4	1/4	G 1/4	58	27	19	80	11,600	3.6	18.3
1U08X-6-04	6	-04	6.4	1/4	G 3/8	58	27	27	80.0	11,600	3.6	18.3
1U08X-6-04C2W	6	-04	6.4	1/4	G 3/8	58	27	27	80	11,600	3.6	18.3

13B8X – BSP male



Design Factor 4:1



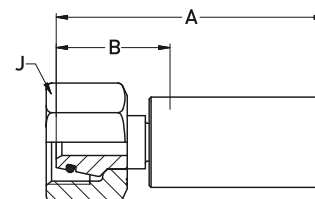

MATERIAL Carbon steel, zinc plated

#						A	B				Nipple ID	Ferrule OD
	DN	size	mm	inch					mm	mm		
13B8X-4-04	6	-04	6.4	1/4	G 1/4	64	32	17	80.0	11,600	3.6	18.3
13B8X-6-04	6	-04	6.4	1/4	G 3/8	67	35	19	80.0	11,600	3.6	18.3

1C98X / 1C9BS – Metric female swivel heavy series with O-ring



MATERIAL Carbon steel, zinc plated, C: Stainless steel

#						A	B				Nipple ID	Ferrule OD
	DN	size	mm	inch					mm	mm		
1C98X-8-04	6	-04	6.4	1/4	M16x1.5	59	27	19	80.0	11,600	3.6	18.3
1C98X-8-04C	6	-04	6.4	1/4	M16x1.5	59	27	19	80.0	11,600	3.6	18.3
1C98X-10-04	6	-04	6.4	1/4	M18x1.5	56	33	22	80.0	11,600	3.6	18.3
1C98X-10-04C	6	-04	6.4	1/4	M18x1.5	56	33	22	80.0	11,600	3.6	18.3
1C98X-12-04	6	-04	6.4	1/4	M20x1.5	69	37	24	80.0	11,600	3.6	18.3
1C9BS-12-06	10	-6	10	3/8	M22x1.5	76	30,5	30	110	15950	6	23,5
1C9BS-14-06	10	-6	10	3/8	M24x1.5	79,5	34	30	110	15950	6	23,5
1C9BS-16-06	10	-6	9,5	3/8	M20x1.5	77	31,5	27	140	20300	6	23,5

Chapter C**Hoses with design factor >2:1**

Hose		
ESH200	– 200 bar Sewer Cleaning Hose.....	C-2
ESH250	– 250 bar Sewer Cleaning Hose.....	C-4
2240D	– TOUGH COVER High pressure hose	C-6
2248D	– TOUGH COVER High pressure hose	C-7
2380N	– High pressure hose.....	C-13
2388N	– High pressure hose.....	C-17
2580N	– High pressure hose.....	C-21
2440D	– Ultra-high pressure hose	C-24
2440N	– Ultra-high pressure hose	C-24
2440D	– TOUGH COVER Ultra-high pressure hose.....	C-25
2448D	– TOUGH COVER Ultra-high pressure hose.....	C-37
2640D	– Ultra-high pressure hose	C-40
2640N	– Ultra-high pressure hose	C-40
2648N	– Ultra-high pressure hose	C-48
PFX21	– Ultra-high pressure hose.....	C-50
PFX25	– Ultra-high pressure hose.....	C-53
PFX30	– Ultra-high pressure hose.....	C-56
PFX38	– Ultra-high pressure hose.....	C-62
PFX40	– Ultra-high pressure hose.....	C-65

ESH200 – Sewer cleaning hose 200 bar



CONSTRUCTION Core tube : Thermoplast
 Pressure reinforcement : High tensile synthetic fibre

Cover : Polyurethane
 Standard colour : Yellow

TEMPERATURE RANGE -10°C up to +50°C

Design Factor >2:1

#												
	DN	size	mm	inch	mm	MPa	psi	MPa	psi	mm	kg/m	
ESH200-08	12	-08	12.4	1/2	21.2	20	2900	50	7250	100	0.24	
ESH200-12	19	-12	19.0	3/4	29.4	20	2900	50	7250	125	0.40	
ESH200-16	25	-16	25.3	1	36.6	20	2900	50	7250	150	0.62	
ESH200-20	32	-20	31.9	1 1/4	46.0	20	2900	50	7250	225	0.92	

Ready-to-install assemblies (further lengths available upon request)

#	Length (m)								Fittings	
	Standard								BSP female swivel	BSP male
	80	100	120	160	180	200	220	240		
ESH200-08	•	•	•	•	•	•	•	•	G 1/2	G 1/2
ESH200-12	•	•	•	•	•	•	•	•	G 1/4	G 3/4
ESH200-16	•	•	•	•	•	•	•	•	G 1	G 1
ESH200-20	•	•	•	•	•	•	•	•	G 1 1/4	G 1 1/4

NOTES

- Ordering examples: ESH200-16-240
- ESH200 is also available as bulk hose on a drum
- Crimp on a Parkrimp system or on a free adjustable crimper: [Crimpsource](#)

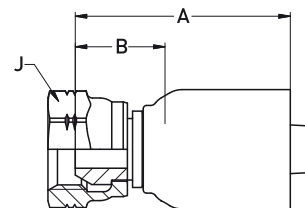
192EH/192ES – BSP female swivel (60° cone)**MATERIAL** Steel, zinc plated

#	⊙				⌚	A	B	J	↗	
	DN	size	mm	inch					MPa	psi
192EH-08-08	12	-08	12.8	1/2	G 1/2	57	22	27	25	3625
192EH-12-12	20	-12	19.6	G 3/4	G3/4	61	22	25	32	3625
192ES-16-16	25	-16	25.0	1	G 1	73	25	41	25	3625
192ES-20-20	32	-20	32.0	1 1/4	G 1 1/4	80	32	50	25	3625

Design Factor >2:1

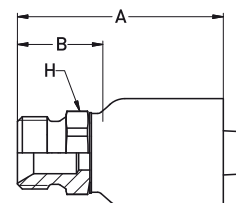
1D9EH/1D9ES – BSP male**MATERIAL** Steel, zinc plated

#	⊙				⌚	A	B	H	↗	
	DN	size	mm	inch					MPa	psi
1D9EH-08-08	12	-08	12.8	1/2	G 1/2	64	30	27	25	3625
1D9EH-12-12	20	-12	19.6	3/4	G 3/4	72	33	32	25	3625
1D9ES-16-16	25	-16	25.0	1	G 1	88	40	36	25	3625
1D9ES-20-20	32	-20	32.0	1 1/4	G 1 1/4	93	45	50	25	3625

ESH250 – Sewer cleaning hose 250 bar









CONSTRUCTION

- Core tube : Thermoplast
- Pressure reinforcement : High tensile synthetic fiber
- Cover : Polyurethane
- Standard colour : Green

TEMPERATURE RANGE -10°C up to +50°C

Design Factor >2:1

#												
	DN	size	mm	inch	mm	MPa	psi	MPa	psi	mm	kg/m	
ESH250-08	12	-08	12.4	1/2	21.2	25	3625	62.5	9060	100	0.24	
ESH250-12	20	-12	19.0	3/4	29.4	25	3625	62.5	9060	125	0.44	
ESH250-16	25	-16	25.4	1	36.5	25	3625	62.5	9060	150	0.60	
ESH250-20	32	-20	32.0	1 1/4	46.0	25	3625	62.5	9060	225	1.00	

Ready-to-install assemblies (further lengths available upon request)

#	Length (m)								Fittings	
	Standard								BSP female swivel	BSP male
	80	100	120	160	180	200	220	240		
ESH250-08	•	•	•	•	•	•	•	•	G 1/2	G 1/2
ESH250-12	•	•	•	•	•	•	•	•	G 3/4	G 3/4
ESH250-16	•	•	•	•	•	•	•	•	G 1	G 1
ESH250-20	•	•	•	•	•	•	•	•	G 1 1/4	G 1 1/4

NOTES

- Ordering example: ESH250-20-180
- ESH250 is also available as bulk hose on a drum
- Crimp on a Parkrimp system or on a free adjustable crimper: [Crimpsource](#)

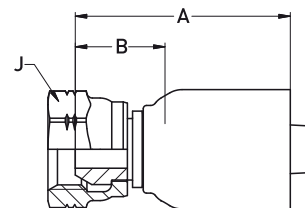
192EH/ES – BSP female swivel (60° cone)**MATERIAL** Steel, zinc plated

#	⊙				⌚	A	B	J	↗	
	DN	size	mm	inch					MPa	psi
192EH-08-08	12	-08	12.8	1/2	G 1/2	57	22	27	25	3625
192EH-12-12	20	-12	19.6	3/4	G 3/4	61	22	32	25	3625
192ES-16-16	25	-16	25.0	1	G 1	73	25	41	25	3625
192ES-20-20	32	-20	32.0	1 1/4	G 1 1/4	80	32	50	25	3625

Design Factor >2:1

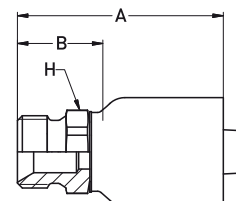
1D9EH/ES – BSP male**MATERIAL** Steel, zinc plated

#	⊙				⌚	A	B	H	↗	
	DN	size	mm	inch					MPa	psi
1D9EH-08-08	12	-08	12.8	1/2	G 1/2	64	30	27	25	3.625
1D9EH-12-12	20	-12	19.6	3/4	G 3/4	68	29	32	25	3.625
1D9ES-16-16	25	-16	25.0	1	G 1	88	40	36	25	3.625
1D9ES-20-20	32	-20	32.0	1 1/4	G 1 1/4	93	45	50	25	3.625

2240D-TOUGH COVER – High pressure hose

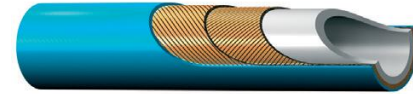

CONSTRUCTION







Core tube : Polyoxymethylene
Pressure reinforcement : Two spiral layers of high tensile steel wire

Cover : Polyamide, extreme wear- and abrasion resistant
Standard colour : blue





TEMPERATURE RANGE

Standard TC : -10 up to +70°C
High temperature version: -10 up to +100°C

Design Factor >2:1

#											
	DN	size	mm	inch		mm	MPa	psi	MPa		
2240D-02V32-TC	3	-02	3.0	1/8	7.0	110	15950	275	39875	60	0.07
2240D-025V32-TC	4	-025	4.0	5/32	7.7	120	17400	300	43500	75	0.10
2240D-03V32-TC	5	-03	4.8	3/16	9.5	110	15950	275	39875	95	0.13
2240D-04V32-TC	6	-04	6.4	1/4	11.5	110	15950	275	39875	110	0.20

High Temperature Version

#											
	DN	size	mm	inch		mm	MPa	psi	MPa		
2240D-02V62-HT-TC	3	-02	3.0	1/8	7.0	110	15950	275	39875	60	0.07
2240D-025V62-HT-TC	4	-025	4.0	5/32	7.7	120	17400	300	43500	75	0.10
2240D-03V62-HT-TC	5	-03	4.8	3/16	9.5	110	15950	275	39875	95	0.13
2240D-04V62-HT-TC	6	-04	6.4	1/4	11.5	110	15950	275	39875	110	0.20

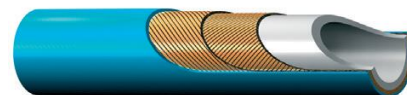

2248D-TOUGH COVER – High pressure hose**CONSTRUCTION**







Core tube : Polyoxymethylene
Pressure reinforcement : Two spiral layers of high tensile steel wire

Cover : Polyamide, extreme wear- and abrasion resistant
Standard colour : blue







TEMPERATURE RANGE

Standard TC : -10 up to +70°C
 High Temperature Version: -10 up to +100°C

Design Factor >2:1

#														
	DN	size	mm	inch	mm	MPa	psi	MPa	psi	mm	kg/m			
2248D-025V32-TC	4	-025	4.0	5/32	7.9	150	21750	375	54375	75	0.10			
2248D-03V32-TC	5	-03	4.9	3/16	9.5	140	20.300	350	50750	95	0.14			
2248D-05V32-TC	8	-05	8.1	5/16	13.4	100	14500	250	36250	120	0.25			

High temperature version

#														
	DN	size	mm	inch	mm	MPa	psi	MPa	psi	mm	kg/m			
2248D-025V62-HT-TC	4	-025	4.0	5/32	7.9	150	21750	375	54375	75	0.10			
2248D-03V62-HT-TC	5	-03	4.9	3/16	9.5	140	20300	350	50750	95	0.14			
2248D-05V62-HT-TC	8	-05	8.1	5/16	13.4	100	14500	250	36250	120	0.25			



Hoses with design factor >2:1



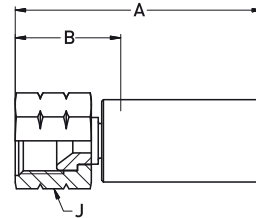

106TX – 1AYTX

106TX – JIC female swivel



MATERIAL Carbon steel zinc plated - Stainless steel on request



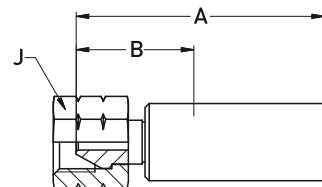

Design Factor >2:1

#						A	B				Nipple ID	Ferrule OD
	DN	size	mm	inch					mm	mm		
106TX-4-025W	4	-025	4.0	5/32	7/16-20 UNF	44	21	17	150	21750	2.3	9.9
106TX-6-03W	5	-03	4.8	3/16	9/16-18 UNF	48	25	19	140	20300	2.8	12.0
106TX-6-04W	6	-04	6.4	1/4	9/16-18 UNF	53	26	19	110	15950	3.8	13.6

1AYTX – Type “M” female swivel



MATERIAL Carbon steel zinc plated - Stainless steel on request

#						A	B				Nipple ID	Ferrule OD
	DN	size	mm	inch					mm	mm		
1AYTX-6-02W	3	-02	3.0	1/8	9/16-18 UNF	47	28	19	110	15950	1.6	9.1
1AYTX-6-025W	4	-025	4.0	5/32	9/16-18 UNF	45	23	19	150	21750	2.3	9.9
1AYTX-8-025W	4	-025	4.0	5/32	3/4-16 UNF	50	28	27	150	21750	2.3	9.9
1AYTX-6-03W	5	-03	4.8	3/16	9/16-18 UNF	50	23	19	150	21750	2.8	12.0
1AYTX-8-03W	5	-03	4.8	3/16	3/4-16 UNF	56	29	27	150	21750	2.8	12.0
1AYTX-6-04W	6	-04	6.4	1/4	9/16-18 UNF	52	25	19	110	15950	3.8	13.6
1AYTX-8-05W	8	-05	7.9	5/16	3/4-16 UNF	64	30	27	100	14500	4.8	16.1

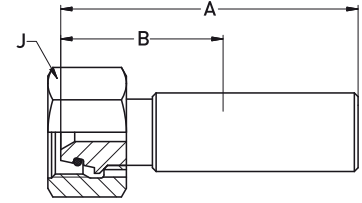
**1C9TX – Metric female swivel
heavy series with O-ring****MATERIAL** Carbon steel zinc plated - Stainless steel on request**NOTE** DN4-6 with support ferrule – DN3 and 8 without support ferrule

#	⊙				⌚	A	B	J	⌚		Nipple ID	Ferrule OD
	DN	size	mm	inch					MPa	psi		
1C9TX-16-02W	3	-02	3.0	1/8	M24x1.5	60	39	30	110	15950	1.6	9.1
1C9TX-16-025W	4	-025	4.0	5/32	M24x1.5	66	35	30	150	21750	2.3	9.9
1C9TX-16-03W	5	-03	4.8	3/16	M24x1.5	74	42	30	150	21750	2.8	12.0
1C9TX-10-04W	6	-04	6.4	1/4	M18x1.5	60	33	22	110	15950	3.8	13.6
1C9TX-12-04W	6	-04	6.4	1/4	M20x1.5	60	33	24	110	15950	3.8	13.6
1C9TX-16-04W	6	-04	6.4	1/4	M24x1.5	70	44	30	110	15950	3.8	13.6
1C9TX-12-05W	8	-05	7.9	5/16	M20x1.5	70	31	24	100	14500	4.8	16.1
1C9TX-14-05W	8	-05	7.9	5/16	M22x1.5	68	29	27	100	14500	4.8	16.1
1C9TX-16-05W	8	-05	7.9	5/16	M24x1.5	71	38	30	100	14500	4.8	16.1

Design Factor >2:1

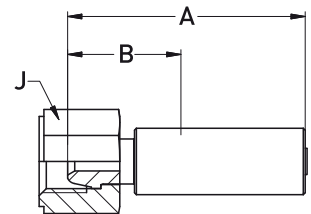
1U0TX – BSP female swivel (ballnose)**MATERIAL** Carbon steel zinc plated - Stainless steel on request

#	⊙				⌚	A	B	J	⌚		Nipple ID	Ferrule OD
	DN	size	mm	inch					MPa	psi		
1U0TX-2-02W	3	-02	3.0	1/8	G 1/8	36	18	12	110	15950	1.6	9.1
1U0TX-4-02W	3	-02	3.0	1/8	G 1/4	44	22	17	110	15950	1.6	9.1
1U0TX-4-025W	4	-025	4.0	5/32	G 1/4	45	23	17	150	21750	2.3	9.9
1U0TX-4-03W	5	-03	4.7	3/16	G 1/4	49	23	17	150	21750	2.8	12.0
1U0TX-4-04W	6	-04	6.3	1/4	G 1/4	51	25	17	110	15950	3.8	13.6
1U0TX-6-05W	8	-05	7.9	5/16	G 3/8	60	26	27	100	14500	4.8	16.1

Hoses with design factor >2:1

101TX – 102TX

101TX – National Pipe Tapered (NPT) male

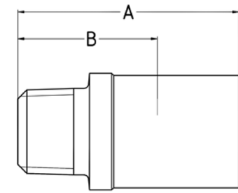

MATERIAL Stainless Steel

Design Factor >2:1

#	⊙				⌚	A	B	⊙		Nipple ID	Ferrule OD
	DN	size	mm	inch				MPa	psi		
101TX-1-02-PL	3	-02	3.0	1/8	1/16-27 NPT	27	11	103.4	15000	1.3	9.0
101TX-2-02-PL	3	-02	3.0	1/8	1/8-27 NPT	24	11	103.4	15000	1.3	9.0
101TX-1-025-PL	4	-025	4.0	5/32	1/16-27 NPT	24	11	103.4	15000	1.8	9.9
101TX-2-025-PL	4	-025	4.0	5/32	1/8-27 NPT	27	11	103.4	15000	1.8	9.9
101TX-4-025-PL	4	-025	4.0	5/32	1/4-18 NPT	32	16	103.4	15000	1.8	9.9
101TX-2-03-PL	5	-03	4.8	3/16	1/8-27 NPT	27	12	103.4	15000	2.8	12.0
101TX-4-03-PL	5	-03	4.8	3/16	1/4-18 NPT	31	16	103.4	15000	2.8	12.0
101TX-2-04-PL	6	-04	6.4	1/4	1/8-27 NPT	29	12	103.4	15000	3.0	13.6
101TX-4-04-PL	6	-04	6.4	1/4	1/4-18 NPT	33	16	103.4	15000	3.0	13.6
101TX-4-05-PL	8	-05	7.9	5/16	1/4-18 NPT	36	14	103.4	15000	4.5	16.1
101TX-6-05-PL	8	-05	7.9	5/16	3/8-18 NPT	38	16	103.4	15000	4.5	16.1

Version with wrench flats on request

102TX – National Pipe Tapered (NPT) female

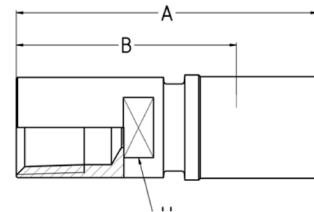

MATERIAL Stainless Steel

#	⊙				⌚	A	B	H	⊙		Nipple ID	Ferrule OD
	DN	size	mm	inch					MPa	psi		
102TX-1-025-PL	4	-025	4.0	5/32	1/16-27 NPT	37	22	9	103.4	15000	1.8	9.9
102TX-1-03-PL	5	-03	4.8	3/16	1/16-27 NPT	37	22	9	103.4	15000	2.8	12.0
102TX-4-04-PL	6	-04	6.4	1/4	1/4-18 NPT	45	28	12	103.4	15000	3.0	13.6

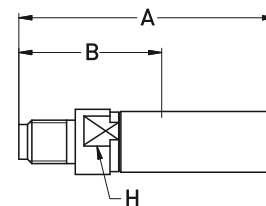
1YZTX – Metric male nozzle nipple**MATERIAL** Stainless Steel

#						A	B			Nipple ID	Ferrule OD	
	DN	size	mm	inch								mm
1YZTX-1-02-PL	3	-02	3.0	1/8	M5	49	28	6	110	15950	1.6	9.1
1YZTX-2-02-PL	3	-02	3.0	1/8	M7	49	28	7	110	15950	1.6	9.1
1YZTX-1-025-PL	4	-025	4.0	5/32	M5	51	29	8	150	21750	2.3	9.9
1YZTX-2-025-PL	4	-025	4.0	5/32	M7	38	23	8	150	21750	1.8	9.9
1YZTX-4-025-PL	4	-025	4.0	5/32	M8	53	30	8	150	21750	2.3	9.9
1YZTX-5-025-PL	4	-025	4.0	5/32	M10x1	32	17	9	150	21750	1.8	9.9
1YZTX-2-03-PL	5	-03	4.8	3/16	M7	55	28	10	150	21750	2.8	12.0
1YZTX-4-03-PL	5	-03	4.8	3/16	M8	53	28	10	150	21750	3.0	12.0
1YZTX-5-04-PL	6	-04	6.4	1/4	M10x1	59	33	13	110	15950	3.0	13.6

Design Factor >2:1

Hoses with design factor >2:1

1YBTX – 1YHTX

1YBTX – BSP male nozzle nipple

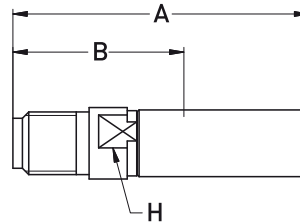

MATERIAL Stainless steel

Design Factor >2:1

#	⊙				⌚	A	B	H	⊙		Nipple ID	Ferrule OD
	DN	size	mm	inch					MPa	psi		
1YBTX-2-02-PL	3	-02	3.0	1/8	G 1/8	48	27	8	110	15950	1.6	9.1
1YBTX-2-025-PL	4	-025	4.0	5/32	G 1/8	53	30	8	150	21750	2.3	9.9
1YBTX-4-025-PL	4	-025	4.0	5/32	G 1/4	54	30	10	150	21750	2.3	9.9
1YBTX-2-03-PL	5	-03	4.8	3/16	G 1/8"	34	19	10	140	20300	2.8	12.0
1YBTX-4-03-PL	5	-03	4.8	3/16	G 1/4	58	31	10	150	21750	2.8	12.0
1YBTX-2-04-PL	6	-04	6.4	1/4	G 1/8"	36	19	10	110	15950	3.0	13.6
1YBTX-4-04-PL	6	-04	6.4	1/4	G 1/4"	39	22	11	110	15950	3.0	13.6
1YBTX-4-05-PL	8	-05	7.9	5/16	G 1/4"	41	21	12	100	14500	4.5	16.1
1YBTX-6-05-PL	8	-05	7.9	5/16	G 3/8	71	37	17	100	14000	4.5	16.1

1YHTX – UNF male nozzle nipple

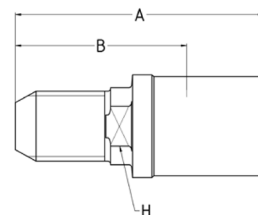

MATERIAL Stainless steel

#	⊙				⌚	A	B	H	⊙		Nipple ID	Ferrule OD
	DN	size	mm	inch					MPa	psi		
1YHTX-4-025-PL	4	-025	4.0	5/32	1/4-28 UNF	40	24	8	150	21750	1.8	9.9
1YHTX-6-03-PL	5	-03	4.8	3/16	3/8-24 UNF	34	19	9	140	20300	2.8	12.0
1YHTX-4-03-PL-LH	5	-03	4.8	3/16	3/8 - 24 UNF LH	54	28	11	150	21750	2.8	12.0
1YHTX-6-03-PL-LH	6	-04	6.4	1/4	3/8 - 24 UNF	56	29	11	150	21750	2.8	13.6
1YHTX-6-04-PL	6	-04	6.4	1/4	3/8 - 24 UNF LH	56	29	11	150	21750	3.0	13.6
1YHTX-6-04-PL-LH	8	-05	7.9	5/16	3/8 - 24 UNF	65	33	13	150	21750	3.0	13.6
1YHTX-6-05-PL-LH	8	-05	7.9	5/16	3/8 - 24 UNF LH	65	33	13	150	21750	4.5	16.1

2380N – High pressure hose









CONSTRUCTION

Core tube : Polyamide
Pressure reinforcement : Two spiral layers and two open spiral layers of high tensile steel wire
Cover : Polyurethane
Standard colour : Black

TEMPERATURE RANGE

-10°C up to +70°C

Design Factor >2:1

#												
	DN	size	mm	inch	mm	MPa	psi	MPa	psi	mm	kg/m	
2380N-025V10W	4	-025	4.0	5/32	9.7	140	20300	350	50750	55	0.16	
2380N-04V00W	6	-04	6.4	1/4	13.4	110	15950	280	40600	70	0.28	
2380N-05V00W	8	-05	8.3	5/16	15.8	103.5	15000	258.8	37500	90	0.35	
2380N-06V10W	10	-06	9.8	3/8	17.9	92	13340	230	33350	120	0.44	
2380N-08V10W	12	-08	12.7	1/2	22.9	88	12760	220	31900	150	0.68	



Hoses with design factor >2:1
1018X/101KY/101LX - 1928X/ 192KY / 192LX - 1U0KY

1018X/ 101KY / 101LX - NPT male

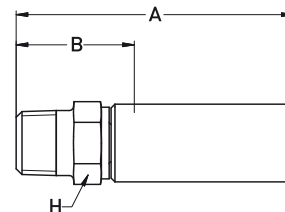

MATERIAL Carbon steel zinc plated, stainless steel on request

#	⊙				📏	A	B	H	⊙		Nipple ID	Ferrule OD
	DN	size	mm	inch					MPa	psi		
1018X-2-025	4	-025	4.0	5/32	1/8 - 27 NPTF	51	24	8	103.4	15000	2.5	13.0
1018X-4-025	4	-025	4.0	5/32	1/4 - 18 NPTF	59	32	13	103.4	15000	2.5	13.0
101KY-2-04	6	-04	6.4	1/4	1/8 - 27 NPTF	56	29	10	103.4	15000	4.0	18.0
101KY-4-04	6	-04	6.4	1/4	1/4 - 18 NPTF	62	35	13	103.4	15000	4.0	18.0
101KY-4-05	8	-05	7.9	5/16	1/4 - 18 NPTF	69	35	13	103.4	15000	5.0	20.0
101KY-6-05	8	-05	7.9	5/16	3/8 - 18 NPTF	69	35	17	103.4	15000	5.0	20.0
101LX-8-08	12	-08	12.7	1/2	1/2 - 14 NPTF	91	37	22	103.4	15000	7.7	30.2

Design Factor >2:1

1928X/ 192KY / 192LX - BSP female swivel (60° cone)

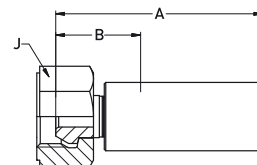

MATERIAL Carbon steel zinc plated, stainless steel on request

#	⊙				📏	A	B	J	⊙		Nipple ID	Ferrule OD
	DN	size	mm	inch					MPa	psi		
1928X-4-025	4	-025	4.0	5/32	G 1/4	48	20	19	140	20300	2.5	13.0
192KY-6-05	8	-05	7.9	5/16	G 3/8	64	25	27	140	20300	5.0	20.0
192KY-8-06	10	-06	9.8	3/8	G 1/2	67	22	30	140	20300	6.0	22.7
192LX-8-08	12	-08	12.7	1/2	G 1/2	75	21	30	140	20300	7.7	30.2

1U0KY – BSP female swivel (ballnose)

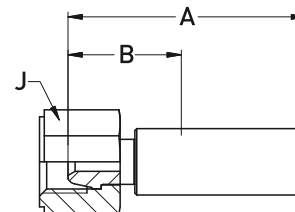

MATERIAL Carbon steel zinc plated, C: Stainless steel

#	⊙				📏	A	B	J	⊙		Nipple ID	Ferrule OD
	DN	size	mm	inch					MPa	psi		
1U0KY-4-04	6	-04	6.3	1/4	G 1/4	51	25	17	140	20300	3.8	18.0

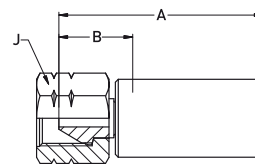
1AY8X/ 1AYKY / 1AYLX
- Type "M" female swivel**MATERIAL** Carbon steel zinc plated, stainless steel on request

#	⊙				⌚	A	B	J	⌚	Nipple ID	Ferrule OD	
	DN	size	mm	inch								mm
1AY8X-6-025	4	-025	4.0	5/32	9/16 - 18 UNF	56	28	19	140	20300	2.5	13.0
1AYKY-6-04	6	-04	6.4	1/4	9/16 - 18 UNF	61	30	22	140	20300	4.0	18.0
1AYKY-8-05	8	-05	7.9	5/16	3/4 - 16 UNF	70	31	27	140	20300	5.0	20.0
1AYLX-11-08	12	-08	12.7	1/2	1 - 12 UNF	80	27	32	140	20300	7.7	30.2

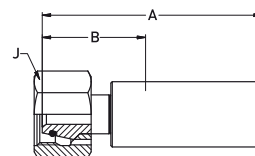
1C98X/ 1C9KY / 1C9LX - Metric female swivel
heavy series with o-ring**MATERIAL** Carbon steel zinc plated, stainless steel on request

#	⊙				⌚	A	B	J	⌚	Nipple ID	Ferrule OD	
	DN	size	mm	inch								mm
1C98X-8-025	4	-025	4.0	5/32	M16x1.5	54	27	19	150	21750	2.5	13.0
1C9KY-10-04	6	-04	6.4	1/4	M18x1.5	68	36	22	150	21750	4.0	18.0
1C9KY-16-04	6	-04	6.4	1/4	M24x1.5	70	44	30	150	21750	4.0	18.0
1C9KY-12-05	8	-05	7.9	5/16	M20x1.5	70	31	24	150	21750	5.0	20.0
1C9KY-14-05	8	-05	7.9	5/16	M22x1.5	68	29	27	150	21750	5.0	20.0
1C9KY-16-05	8	-05	7.9	5/16	M24x1.5	77	38	30	150	21750	5.0	20.0
1C9KY-14-06	10	-06	9.5	3/8	M22x1.5	76	30	30	150	21750	6.0	22.7
1C9LX-16-08	12	-08	12.7	1/2	M24x1.5	88	34	30	150	21750	7.7	30.2



Design Factor >2:1

Hoses with design factor >2:1
 1Y4KY/1Y4LX - 1YBKY - 1TMKY

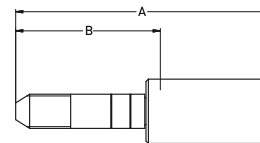
1Y4KY/1Y4LX - High pressure tube nipple UNF - LH thread



MATERIAL Carbon steel zinc plated, stainless steel on request



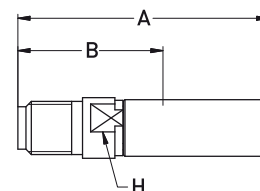

#						A	B			Nipple ID	Ferrule OD
	DN	size	mm	inch				MPa	psi		
1Y4KY-9-05	8	-05	7.9	5/16	9/16-18 UNF LH	99	60	140	20300	5.0	20.0
1Y4LX-9-08	12	-06	12.7	1/2	9/16-18 UNF LH	124	70	140	20300	7.7	30.7

Design Factor >2:1

1YBKY - BSP male nozzle nipple



MATERIAL Carbon steel zinc plated, stainless steel on request

#						A	B				Nipple ID	Ferrule OD
	DN	size	mm	inch					MPa	psi		
1YBKY-2-04	6	-04	6.4	1/4	G 1/8	58	31	10	150	21750	4.0	18.0
1YBKY-4-04	6	-04	6.4	1/4	G 1/4	62	36	10	110	15950	4.0	18.0
1YBKY-4-05	8	-05	7.9	5/16	G 1/4	68	35	13	100	14500	5.0	20.0
1YBKY-6-05	8	-05	7.9	5/16	G 3/8	71	37	17	100	14500	5.0	20.0

1TMKY - Polyflex Lok components



#	Description
1TMKY-8-05-HPK	Fitting for DN8 hoses incl. caps (refer to chapter D)

2388N – High pressure hose

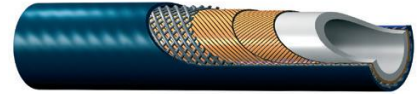







CONSTRUCTION

Core tube : Polyamide
 Pressure reinforcement : Two spiral layers and two open spiral layers of high tensile steel wire
 Cover : Polyurethane
 Standard colour : Blue

TEMPERATURE RANGE

-10°C up to +70°C

Design Factor >2:1

#														
	DN	size	mm	inch	mm	MPa	psi	MPa	psi	mm	kg/m			
2388N-04V12W	6	-04	6.3	1/4	13.4	128	18.560	320	46400	80	0.30			
2388N-06V12W	12	-06	10.1	3/8	19.8	125	18.125	312.5	45310	100	0.65			
2388N-08V12W	12	-08	13.0	1/2	23.0	110	15950	275	39875	120	0.80			



1C9KY / 1C9BS – Metric female swivel heavy series with O-ring

MATERIAL Carbon steel zinc plated, stainless steel on request

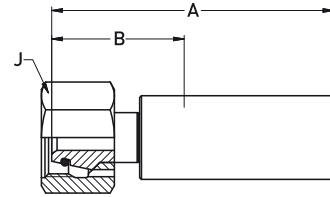

Design Factor >2:1

#	⊙				⌚	A	B	J	⊙		Nipple ID	Ferrule OD
	DN	size	mm	inch					MPa	psi		
1C9KY-10-04	6	-04	6.4	1/4	M18X1.5	68	36	22	150	21750	3.8	18,0
1C9KY-16-04	6	-04	6.4	1/4	M24X1.5	70	44	30	150	21750	3.8	18,0
1C9BS-12-06	10	-06	9.5	3/8	M20x1.5	77	32	27	150	21750	6.0	23,5
1C9BS-14-06	10	-06	9.5	3/8	M22x1.5	76	30,5	30	150	21750	6.0	23,5
1C9BS-16-06	10	-06	9.5	3/8	M24x1.5	80	34	30	150	21750	6.0	23,5
1C9BS-14-08	12	-08	12.7	1/2	M22x1.5	89	36	27	150	21750	8.0	28,5
1C9BS-16-08	12	-08	12.7	1/2	M24x1.5	89	36	30	150	21750	8.0	28,5
1C9BS-25-08	12	-08	12.8	1/2	M36x2	88	42	46	150	21750	8.0	28,5

1U0KY – BSP female swivel (ballnose)

MATERIAL Carbon steel zinc plated, C: Stainless steel

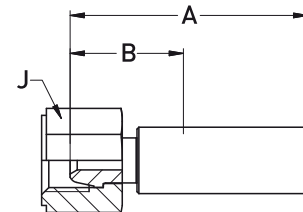

#	⊙				⌚	A	B	J	⊙		Nipple ID	Ferrule OD
	DN	size	mm	inch					MPa	psi		
1U0KY-4-04	6	-04	6.3	1/4	G 1/4	51	25	17	140	20300	3.8	18.0

192BS – BSP female swivel (60° cone)

MATERIAL Carbon steel zinc plated, stainless steel on request

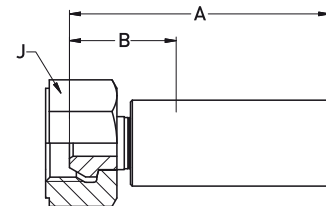

#	⊙				⌚	A	B	J	⊙		Nipple ID	Ferrule OD
	DN	size	mm	inch					MPa	psi		
192BS-6-06	10	-06	9.5	3/8	G 3/8	68	23	22	140	20300	5.7	23.5
192BS-8-06	10	-06	9.5	3/8	G 1/2	67	22	30	140	20300	5.7	23.5
192BS-8-08	12	-08	12.7	1/2	G 1/2	81	28	30	140	20300	7.7	28.5

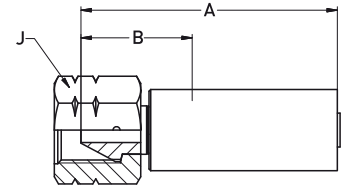
1AYKY / 1AYBS – Type “M” female swivel**MATERIAL** Carbon steel, zinc plated, C: Stainless steel

#	⊙				⌚	A	B	J	⌚	Nipple ID	Ferrule OD	
	DN	size	mm	inch								mm
1AYKY-6-04	6	-04	6.4	1/4	9/16-18 UNF	61	30	22	140	20300	3.8	18.0
1AYBS-8-06	10	-06	9.5	3/8	3/4-16 UNF	68	23	22	140	20300	5.7	23.5
1AYBS-11-08	12	-08	12.7	1/2	1-12 UNF	81	28	30	140	20300	7.7	28.5

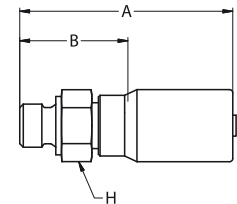
1D9KY / 1D9BS – BSP male 60° cone**MATERIAL** Carbon steel, zinc plated, C: Stainless steel

#	⊙				⌚	A	B	H	⌚	Nipple ID	Ferrule OD	
	DN	size	mm	inch								mm
1D9KY-4-04	6	-04	6.3	1/4	G 1/4	62	36	19	140	20300	3.8	18.0
1D9BS-8-08	12	-08	12,8	1/2	G 1/2	81	35	27	140	20300	8.0	28.5

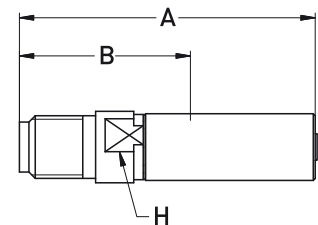
1YBKY – BSP male nozzle nipple**MATERIAL** Carbon steel zinc plated, C: Stainless steel

#	⊙				⌚	A	B	H	⌚	Nipple ID	Ferrule OD	
	DN	size	mm	inch								mm
1YBKY-4-04	6	-04	6.4	1/4	G 1/4	62	36	10	110	15950	3.8	18.0

Design Factor >2:1

101KY / 101BS – National Pipe Tapered (NPT) male

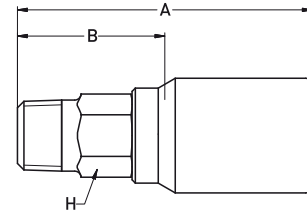

MATERIAL Carbon steel zinc plated, C: Stainless steel

Design Factor >2:1

#						A	B				Nipple ID	Ferrule OD
	DN	size	mm	inch					MPa	psi		
101KY-4-04	6	-04	6.4	1/4	1/4 NPT	63	32	13	103.5	15000	3.8	18.0
101BS-6-06	10	-06	9.5	3/8	3/8 NPT	76	31	19	103.5	15000	5.7	23.5
101BS-8-08	12	-08	12.7	1/2	1/2 NPT	91	38	22	103.5	15000	7.7	28.5

1TMBS – Polyflex Lok components



#	Description
1TMBS-9-08-HPK	Fitting for DN12 hoses incl. caps (refer to chapter D)

2580N – High pressure hose









CONSTRUCTION

Core tube : Polyamide
 Pressure reinforcement : Four spiral layers and two open spiral layers of high tensile steel wire
 Cover : Polyurethane
 Standard colour : Dark blue

TEMPERATURE RANGE

-10°C up to +70°C

Design Factor >2:1

#														
	DN	size	mm	inch	mm	MPa	psi	MPa	psi	mm	kg/m			
2580N-06V12	10	-06	9.8	3/8	21.6	160	23200	400	58000	95	0.94			
2580N-08V12	12	-08	12.9	1/2	25.0	140	20300	350	50750	150	1.19			
2580N-12V12	20	-12	19.8	3/4	32.6	120	17400	300	43500	170	1.76			



Hoses with design factor >2:1

101BL – 192BL

101BL – National Pipe Tapered (NPT) male

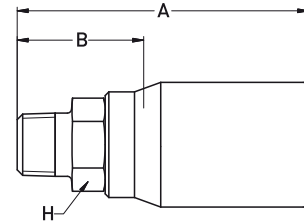

MATERIAL Carbon steel, zinc plated, C: Stainless steel

Design Factor >2:1

#	⊙				⌚	A	B	H	⊙		Nipple ID	Ferrule OD
	DN	size	mm	inch					MPa	psi		
101BL-6-06	10	-06	9.5	3/8	3/8 NPT	80	35	22	103.4	15000	5.5	28.5
101BL-8-08	12	-08	12.7	1/2	1/2 NPT	90	45	22	103.4	15000	7.5	30.5
101BL-8-08C	12	-08	12.7	1/2	1/2 NPT	90	45	22	103.4	15000	7.5	30.5
101BL-12-12	20	-12	19.0	3/4	3/4 NPT	98	45	30	103.4	15000	12.5	39.8

192BL – BSP female swivel (60° cone)

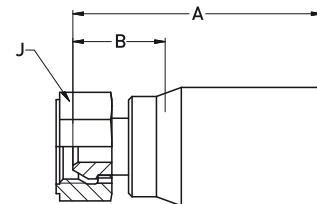

MATERIAL Carbon steel, zinc plated, C: Stainless steel

#	⊙				⌚	A	B	J	⊙		Nipple ID	Ferrule OD
	DN	size	mm	inch					MPa	psi		
192BL-6-06	10	-06	9.5	3/8	G3/8	68	24	22	160	23200	5.5	28.5
192BL-8-06	10	-06	9.5	3/8	G1/2	71	26	27	160	23200	5.5	28.5
192BL-8-08	12	-08	12.7	1/2	G1/2	71	26	27	140	20300	7.5	30.5
192BL-8-08C	12	-08	12.7	1/2	G1/2	71	26	27	140	20300	7.5	30.5
192BL-16-12	20	-12	19.0	3/4	G1	82	28	41	120	17400	12.5	39.8

1C9BL – Metric female swivel heavy series with O-ring

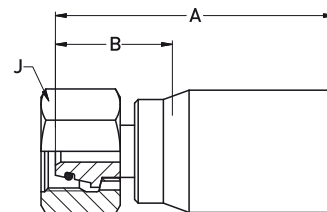

MATERIAL Carbon steel, zinc plated, C: Stainless steel

#	⊙				⌚	⊙	A	B	J	⌚	Nipple		Ferrule OD
	DN	size	mm	inch							mm	mm	
1C9BL-12-06	10	-06	9.5	3/8	M20x1,5	12	78	34	27	160	23200	5.7	28.5
1C9BL-16-06	10	-06	9.5	3/8	M24 x 1.5	16	84	36	30	160	23200	5.5	28.5
1C9BL-14-08	12	-08	12.7	1/2	M22 x 1.5	14	80	36	27	140	20300	7.5	30.5
1C9BL-14-08C	12	-08	12.7	1/2	M22 x 1.5	14	80	36	27	140	20300	7.5	30.5
1C9BL-16-08	12	-08	12.7	1/2	M24 x 1.5	16	80	36	30	140	20300	7.5	30.5
1C9BL-16-08C	12	-08	12.7	1/2	M24 x 1.5	16	80	36	30	140	20300	7.5	30.5
1C9BL-25-12	20	-12	19.0	3/4	M36 x 2.0	25	97	44	46	120	17400	12.5	39.8

Design Factor >2:1

1AYBL – Type “M” female swivel

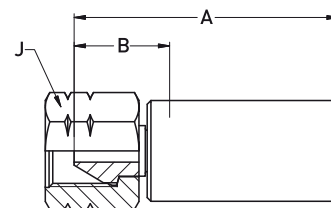

MATERIAL Carbon steel, zinc plated, C: Stainless steel

#	⊙				⌚	A	B	J	⌚	Nipple		Ferrule OD
	DN	size	mm	inch						mm	mm	
1AYBL-8-06	10	-06	9.5	3/8	3/4-16 UNF	81	37	27	160	23200	5.7	28.5
1AYBL-11-06	10	-06	9.5	3/8	1 - 12 UNF	77	31	32	160	23200	5.5	28.5
1AYBL-11-08	12	-08	12.7	1/2	1 - 12 UNF	77	31	32	140	20300	7.5	30.5
1AYBL-11-08C	12	-08	12.7	1/2	1 - 12 UNF	77	31	32	140	20300	7.5	30.5

1TMBL – Polyflex Lok components



#	Description
1TMBL-9-08-HPK	Fitting for DN12 hoses incl. caps (refer to chapter D)

2440D / 2440N – Ultra-high pressure hose

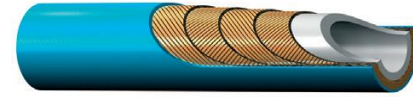







CONSTRUCTION Core tube : DN 3-8: Polyoxymethylene; DN 10-25: Polyamide
 Pressure reinforcement : Four spiral layers of maximum tensile steel wire

Cover : Polyamide
 Standard colour : DN 3-8: blue; DN 10-25: black

TEMPERATURE RANGE -10°C up to +70°C

Design Factor >2:1

#														
	DN	size	mm	inch	mm	MPa	psi	MPa	psi	mm	kg/m			
2440D-02V32	3	-02	3.0	1/8	7.9	210	30450	525	76125	100	0.12			
2440D-025V32	4	-025	4.0	5/32	10.4	220	31900	550	79750	100	0.21			
2440D-03V32	5	-03	4.8	3/16	11.5	180	26100	450	65250	130	0.28			
2440D-04V32	6	-04	6.4	1/4	12.5	164	23780	410	59450	155	0.33			
2440D-05V32	8	-05	8.1	5/16	15.1	150	21750	375	54375	175	0.44			
2440N-06V30	10	-06	9.7	3/8	19.4	140	20300	350	50750	190	0.73			
2440N-08V30	12	-08	12.8	1/2	22.5	140	20300	350	50750	200	0.94			
2440N-12V30	20	-12	19.6	3/4	30.0	100	14500	250	36250	250	1.39			
2440N-16V30	25	-16	25.0	1	37.0	90	13050	225	32625	300	2.00			



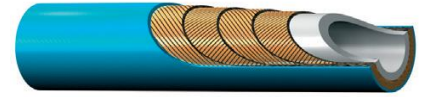





2440D-TOUGH COVER – Ultra-high pressure hose

CONSTRUCTION	Core tube	: DN 3-8: Polyoxymethylene; DN 10-12: Polyamide
	Pressure reinforcement	: Four spiral layers of maximum tensile steel wire
	Cover	: Polyamide, extreme wear- and abrasion resistant
	Standard colour	: blue

TEMPERATURE RANGE -10°C up to +70°C

Design Factor >2:1

#														
	DN	size	mm	inch	mm	MPa	psi	MPa	psi	mm	kg/m			
2440D-02V32-TC	3	-02	3.0	1/8	7.9	210	30450	525	76125	100	0.12			
2440D-025V32-TC	4	-025	3.9	5/32	10.4	220	31900	550	79750	100	0.21			
2440D-03V32-TC	5	-03	4.7	3/16	11.5	180	26100	450	65250	130	0.28			
2440D-04V32-TC	6	-04	6.3	1/4	12.5	164	23780	410	59450	155	0.33			
2440D-05V32-TC	8	-05	8.0	5/16	15.1	150	21750	375	54375	175	0.44			



Hoses with design factor >2:1

1C9LX

1C9LX – Metric female swivel heavy series with O-ring

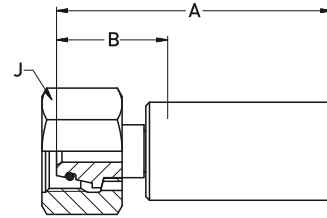

MATERIAL High strength carbon steel, zinc plated, C: Stainless steel

Design Factor >2:1

#	⊙				⌚	A	B	J	⊙		Nipple ID	Ferrule OD
	DN	size	mm	inch					MPa	psi		
1C9LX-8-025	4	-025	4.0	5/32	M16x1.5	67	30	22	220	31900	1.7	14.6
1C9LX-8-025C	4	-025	4.0	5/32	M16x1.5	67	30	22	220	31900	1.7	14.6
1C9LX-16-03	5	-03	4.8	3/16	M24x1.5	80	38	30	180	26100	2.1	15.3
1C9LX-10-04	6	-04	6.4	1/4	M18x1.5	76	31	27	164	23780	2.9	17.0
1C9LX-10-04C	6	-04	6.4	1/4	M18x1.5	76	31	27	164	23780	2.9	17.0
1C9LX-16-04	6	-04	6.4	1/4	M24x1.5	85	40	30	164	23780	2.9	17.0
1C9LX-14-05	8	-05	7.9	5/16	M22x1.5	84	40	30	150	21750	3.7	21.0
1C9LX-16-05	8	-05	7.9	5/16	M24x1.5	84	40	30	150	21750	3.7	21.0
1C9LX-16-05C	8	-05	7.9	5/16	M24x1.5	84	40	30	150	21750	3.7	21.0
1C9LX-12-06	10	-06	9.5	3/8	M20x1.5	76	30	27	140	20300	5.8	26.9
1C9LX-14-06	10	-06	9.5	3/8	M22x1.5	76	30	30	140	20300	5.8	26.9
1C9LX-14-06C	10	-06	9.5	3/8	M22x1.5	76	30	30	140	20300	5.8	26.9
1C9LX-16-06	10	-06	9.5	3/8	M24x1.5	80	34	30	140	20300	5.8	26.9
1C9LX-16-06C	10	-06	9.5	3/8	M24x1.5	80	34	30	140	20300	5.8	26.9
1C9LX-16-08	12	-08	12.7	1/2	M24x1.5	88	34	30	140	20300	6.7	30.7
1C9LX-16-08C	12	-08	12.7	1/2	M24x1.5	88	34	30	140	20300	6.7	30.7
1C9LX-25-12	20	-12	19.0	3/4	M36x2	92	39	46	100	14500	12.7	38.5
1C9LX-25-12C4462	20	-12	19.0	3/4	M36x2	92	39	46	100	14500	12.7	38.5
1C9LX-30-16	25	-16	25.4	1	M42x2	98	45	50	90	13050	17.2	45.3
1C9LX-30-16C4462	25	-16	25.4	1	M42x2	98	45	50	90	13050	17.2	45.3

6AYLX / 1AYLX – Type “M” female swivel

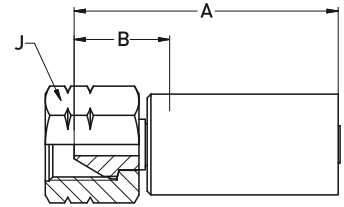

MATERIAL High strength carbon steel, zinc plated, C: Stainless steel

#	⊙				⋈	A	B	J	⊙		Nipple ID	Ferrule OD
	DN	size	mm	inch					MPa	psi		
1AYLX-6-02	3	-02	3.0	1/8	9/16 - 18UNF	48	26	22	207	30000	1.5	9.8
1AYLX-6-025	4	-025	4.0	5/32	9/16 - 18 UNF	64	33	22	220	31900	1.7	14.6
1AYLX-6-03	5	-03	4.8	3/16	9/16 - 18UNF	66	26	22	180	26100	2.1	15.3
1AYLX-6-03C	5	-03	4.8	3/16	9/16 - 18 UNF	67	26	22	180	26100	2.1	15.3
1AYLX-6-04	6	-04	6.4	1/4	9/16 - 18UNF	61	29	22	164	23780	2.9	17.0
1AYLX-6-04C	6	-04	6.4	1/4	9/16 - 18UNF	61	29	22	164	23780	2.9	17.0
1AYLX-8-05	8	-05	7.9	5/16	3/4 - 16UNF	74	30	27	150	21750	3.7	21.0
1AYLX-8-05C	8	-05	7.9	5/16	3/4 - 16 UNF	70	31	27	150	21750	3.7	21.0
1AYLX-8-06	10	-06	9.5	3/8	3/4 - 16UNF	70	26	27	140	20300	5.8	26.9
1AYLX-8-06C	10	-06	9.5	3/8	3/4 - 16 UNF	70	25	27	140	20300	5.8	26.9
1AYLX-11-08	12	-08	12.7	1/2	1 - 12 UNF	80	27	32	140	20300	6.7	30.7
1AYLX-11-08C	12	-08	12.7	1/2	1 - 12 UNF	80	27	32	140	20300	6.7	30.7
1AYLX-16-12	20	-12	19.0	3/4	1 5/16-12UNF	82	29	41	100	14500	12.7	38.5
1AYLX-16-12C4462	20	-12	19.0	3/4	1 5/16-12UNF	82	29	41	100	14500	12.7	38.5
6AYLX-16-16C	25	-16	25.4	1	1 5/16 - 12 UNF	100	40	38	90	13050	17.5	40.3

Design Factor >2:1

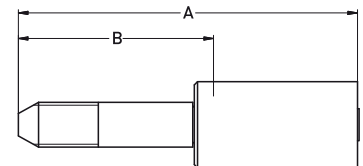
1YMLX – High pressure tube nipple
metric – LH thread

MATERIAL High strength carbon steel, zinc plated, C: Stainless steel

#	⊙				⋈	A	B	⊙		Nipple ID	Ferrule OD
	DN	size	mm	inch				MPa	psi		
1YMLX-6-04	6	-04	6.4	1/4	M14X1.5-LH	112	80	250	36250	2.9	17.0
1YMLX-6-05	8	-05	7.9	5/16	M14x1.5-LH	110	66	250	36250	3.7	21.0
1YMLX-11-08	12	-08	12.7	1/2	M18x1.5-LH	120	65	250	36250	6.7	30.7

Hoses with design factor >2:1

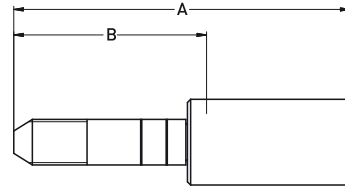

1YALX / 1Y4LX

1YALX / 1Y4LX – High pressure tube nipple UNF – LH thread



MATERIAL Special materials, C: Stainless steel

Design Factor >2:1

#						A	B			Nipple ID	Ferrule OD
	DN	size	mm	inch				MPa	psi		
1Y4LX-4-02	3	-02	3.0	1/32	1/4 - 28UNF-LH	63	41	250	36250	1.5	9.8
1YALX-1-025	4	-025	4.0	5/32	1/4 - 28UNF-LH	87	50	220	31900	1.7	14.6
1YALX-1-025C	4	-025	4.0	5/32	1/4 - 28UNF-LH	87	50	220	31900	1.7	14.6
1YALX-3-025	4	-025	4.0	5/32	3/8 - 24UNF-LH	89	50	220	31,900	1.7	14.6
1YALX-1-03	5	-03	4.8	3/16	1/4 - 28UNF-LH	92	53	180	26100	1.7	15.3
1YALX-1-03C	5	-03	4.8	3/16	1/4 - 28UNF-LH	92	53	180	26100	1.7	15.3
1YALX-3-03	5	-03	4.8	3/16	3/8 - 24UNF-LH	99	57	180	26100	2.1	15.3
1YALX-3-03C	5	-03	4.8	3/16	3/8 - 24UNF-LH	99	57	180	26100	2.1	15.3
1YALX-6-03	5	-03	4.8	3/16	9/16 - 18UNF-LH	108	67	180	26100	2.1	15.3
1YALX-6-03C	5	-03	4.8	3/16	9/16 - 18UNF-LH	108	67	180	26100	2.1	15.3
1YALX-3-04	6	-04	6.4	1/4	3/8 - 24UNF-LH	102	58	164	23,780	2.9	17.0
1YALX-3-04C	6	-04	6.4	1/4	3/8 - 24UNF-LH	102	58	164	23,780	2.9	17.0
1YALX-6-04	6	-04	6.4	1/4	9/16 - 18UNF-LH	112	67	164	23,780	2.9	17.0
1YALX-3-05C	8	-05	7.9	5/16	3/8 - 24UNF-LH	103	59	150	21750	3.7	21.0
1YALX-6-05	8	-05	7.9	5/16	9/16 - 18UNF-LH	110	66	150	21750	3.7	21.0
1YALX-6-05C	8	-05	7.9	5/16	9/16 - 18UNF-LH	110	66	150	21750	3.7	21.0
1YALX-6-06	10	-06	9.5	3/8	9/16 - 18UNF-LH	106	62	140	20300	5.8	26.9
1YALX-6-06C	10	-06	9.5	3/8	9/16 - 18UNF-LH	106	62	140	20300	5.8	26.9
1Y4LX-9-08	12	-08	12.7	1/2	9/16 - 18UNF-LH	124	70	140	20300	6.7	30.7
1Y4LX-9-08C	12	-08	12.7	1/2	9/16 - 18UNF-LH	124	70	140	20300	6.7	30.7

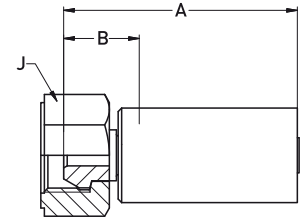
192LX / 692LX – BSP female swivel (60° cone)**MATERIAL** High strength carbon steel, zinc plated, C: Stainless steel

#	⊙				⌚	A	B	J	⊙		Nipple ID	Ferrule OD
	DN	size	mm	inch					MPa	psi		
192LX-4-03	5	-03	4.8	3/16	G 1/4	64	25	22	180	26100	2.1	15.3
192LX-4-03C	5	-03	4.8	3/16	G 1/4	64	25	22	180	26100	2.1	15.3
192LX-6-05	8	-05	7.9	5/16	G 3/8	69	25	27	150	21750	3.7	21.0
192LX-6-05C	8	-05	7.9	5/16	G 3/8	69	25	27	150	21750	3.7	21.0
192LX-8-06	10	-06	9.5	3/8	G 1/2	66	22	30	140	20300	5.8	26.9
192LX-8-06C	10	-06	9.5	3/8	G 1/2	66	22	30	140	20300	5.8	26.9
192LX-8-08	12	-08	12.7	1/2	G 1/2	75	21	30	140	20300	6.7	30.7
192LX-8-08C	12	-08	12.7	1/2	G 1/2	75	21	30	140	20300	6.7	30.7
192LX-12-08C	12	-08	12.7	1/2	G 3/4	85	30	32	140	20300	6.7	30.7
192LX-16-12	20	-12	19.0	3/4	G 1	77	24	41	100	14500	12.7	38.5
192LX-16-12C4462	20	-12	19.0	3/4	G 1	77	24	41	100	14500	12.7	38.5
692LX-16-16C	25	-16	25.4	1	G 1	78	25	38	90	13050	17.5	40.3
192LX-20-16	25	-16	25.4	1	G 1 1/4	78	25	50	90	13050	17.2	45.3

Design Factor >2:1

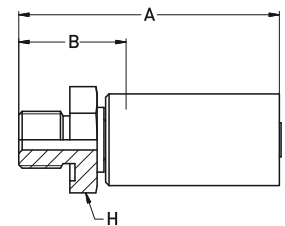
1Y9LX – BSP male for USIT ring**MATERIAL** High strength carbon steel, zinc plated, C: Stainless steel

#	⊙				⌚	A	B	H	⊙		Nipple ID	Ferrule OD
	DN	size	mm	inch					MPa	psi		
1Y9LX-4-03	5	-03	4.8	3/16	G 1/4	72	32	22	180	26100	2.1	15.3
1Y9LX-4-03C	5	-03	4.8	3/16	G 1/4	72	32	22	180	26100	1.4	15.3
1Y9LX-6-05	8	-05	7.9	5/16	G 3/8	82	38	27	150	21750	3.7	21.0
1Y9LX-8-08	12	-08	12.7	1/2	G 1/2	87	32	36	130	18850	6.7	30.7



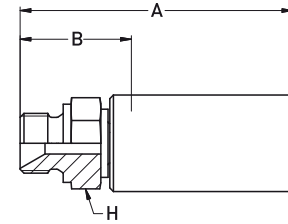

Hoses with design factor >2:1
1D9LX – 1C3LX

1D9LX – BSP male



MATERIAL High strength carbon steel, zinc plated



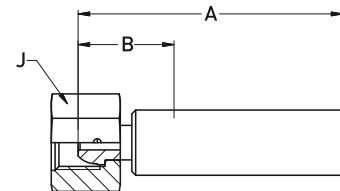

Design Factor >2:1

#						A	B				Nipple ID	Ferrule OD
	DN	size	mm	inch					mm	mm		
1D9LX-4-025	4	-025	4.0	5/32	G 1/4	73	36	19	220	31900	1.7	14.6
1D9LX-4-03	5	-03	4.8	3/16	G 1/4	77	35	19	180	26100	2.1	15.3
1D9LX-4-04	6	-04	6.4	1/4	G 1/4	80	36	19	164	23,780	2.9	17.0
1D9LX-4-05	8	-05	7.9	5/16	G 1/4	77	33	19	150	21750	3.7	21.0
1D9LX-4-06	10	-06	9.5	3/8	G 1/4	76	30	19	140	20300	5.8	26.9

1C3LX – Metric female swivel light series



MATERIAL High strength carbon steel, zinc plated, C: Stainless steel

#						A	B				Nipple ID	Ferrule OD
	DN	size	mm	inch					mm	mm		
1C3LX-8-025	4	-025	4.0	5/32	M14x1,5	63	26	22	220	31900	1.7	14.6
1C3LX-8-03	5	-03	4.8	3/16	M14x1.5	64	25	22	180	26100	2.1	15.3
1C3LX-8-03C	5	-03	4.8	3/16	M14x1.5	64	25	22	180	26100	2.1	15.3
1C3LX-8-04	6	-04	6.4	1/4	M14x1.5	69	25	22	164	23780	2.9	17.0
1C3LX-8-04C	6	-04	6.4	1/4	M14x1.5	69	25	22	164	23780	2.9	17.0

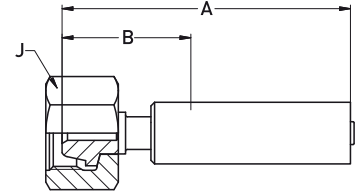
1C6LX – Metric female swivel heavy series**MATERIAL** High strength carbon steel, zinc plated

#	⊙				⌚	A	B	J	↗		Nipple ID	Ferrule OD
	DN	size	mm	inch					MPa	psi		
1C6LX-12-05	8	-05	7.9	5/16	M20x1.5	78	34	27	150	21750	3.7	21.0

Design Factor >2:1

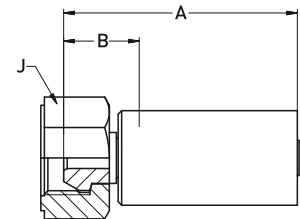
1MRLX – Metric female swivel 59° cone**MATERIAL** High strength carbon steel, zinc plated

#	⊙				⌚	A	B	J	↗		Nipple ID	Ferrule OD
	DN	size	mm	inch					MPa	psi		
1MRLX-6-02	3	-02	3.0	1/32	M12x1,5	43	21	17	220	31900	1.5	9.8
1MRLX-8-02	3	-02	3.0	1/32	M14x1,5	48	26	22	220	31900	1.5	9.8
1MRLX-8-025	4	-025	4.0	5/32	M14x1,5	65	34	22	220	31900	1.4	14.6
1MRLX-6-03	5	-03	4.8	3/16	M12x1,5	92	53	17	180	26100	2.1	15.3
1MRLX-8-03	5	-03	4.8	3/16	M14x1,5	66	26	22	180	26100	2.1	15.3

Hoses with design factor >2:1

101LX

101LX – National Pipe Tapered (NPT) male

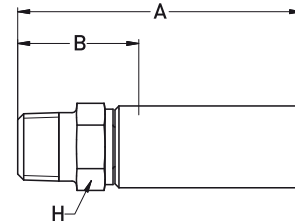





MATERIAL Special materials, C: Stainless steel

Design Factor >2:1

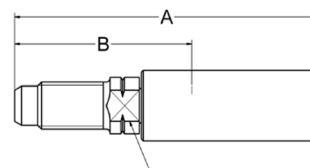
#	⊙				⌚	A	B	H	⊙		Nipple ID	Ferrule OD
	DN	size	mm	inch					MPa	psi		
101LX-4-03	5	-03	4.8	3/16	1/4 NPT	75	33	14	103.5	15000	2.1	15.3
101LX-4-03C	5	-03	4.8	3/16	1/4 NPT	75	33	14	103.5	15000	2.1	15.3
101LX-4-04	6	-04	6.4	1/4	1/4 NPT	80	36	14	103.5	15000	2.9	17.0
101LX-4-04C	6	-04	6.4	1/4	1/4 NPT	80	36	14	103.5	15000	2.9	17.0
101LX-6-04	6	-04	6.4	1/4	3/8 NPT	80	36	19	103.5	15000	2.9	17.0
101LX-6-04C	6	-04	6.4	1/4	3/8 NPT	80	36	19	103.5	15000	2.9	17.0
101LX-4-05	8	-05	7.9	5/16	1/4 NPT	76	31	14	103.5	15000	3.7	21.0
101LX-4-05C	8	-05	7.9	5/16	1/4 NPT	76	31	14	103.5	15000	3.7	21.0
101LX-6-06	10	-06	9.5	3/8	3/8 NPT	76	30	19	103.5	15000	5.8	26.9
101LX-6-06C	10	-06	9.5	3/8	3/8 NPT	76	30	19	103.5	15000	5.8	26.9
101LX-8-06	10	-06	9.5	3/8	1/2 NPT	81	35	22	103.5	15000	5.8	26.9
101LX-8-06C	10	-06	9.5	3/8	1/2 NPT	81	35	22	103.5	15000	5.8	26.9
101LX-8-08	12	-08	12.7	1/2	1/2 NPT	91	37	22	103.5	15000	6.7	30.7
101LX-8-08C	12	-08	12.7	1/2	1/2 NPT	91	37	22	103.5	15000	6.7	30.7
101LX-12-12	20	-12	19.0	3/4	3/4 NPT	124	57	35	69.0	10000	12.7	38.5
101LX-16-16	25	-16	25.4	1	1 NPT	125	64	35	69.0	10000	17.2	45.3

6YHLX – UNF male nozzle nipple

**MATERIAL** Stainless steel**NOTE** ProLance fitting

#						A	B	H			Nipple ID mm	Ferrule OD mm
	DN	size	mm	inch		mm	mm	mm	MPa	psi		
6YHLX-4-02-PL	3	-02	3.0	1/32	1/4-28 UNF	52	30	8	280	40600	1.5	9.8
6YHLX-4-2AC-PL	4	-025	4.0	5/32	1/4 - 28 UNF	58	26	8	301	43645	1.6	11.6
6YHLX-4-2AC-PL-LH	4	-025	4.0	5/32	1/4 - 28 UNF LH	58	26	8	301	43645	1.6	11.6
6YHLX-6-2AC-PL-LH	4	-025	4.0	5/32	3/8-24 UNF LH	62	30	10	301	43645	1.6	11.6
6YHLX-4-3C-PL	5	-03	4.8	3/16	1/4 - 28 UNF	62	29	10	280	40600	2.1	12.5
6YHLX-4-3C-PL-LH	5	-03	4.8	3/16	1/4 - 28 UNF LH	62	29	10	280	40600	2.1	12.5
6YHLX-6-3C-PL	5	-03	4.8	3/16	3/8 - 24 UNF	65	32	10	250	36250	2.1	12.5
6YHLX-6-3C-PL-LH	5	-03	4.8	3/16	3/8 - 24 UNF LH	65	32	10	250	36250	2.1	12.5
6YHLX-6-4C-PL	6	-04	6.4	1/4	3/8 - 24 UNF	66	36	11	250	36250	3.4	15.0
6YHLX-9-4C-PL	6	-04	6.4	1/4	9/16-18 UNF	67	37	16	138	20000	3.4	15.0
6YHLX-6-4C-PL-LH	6	-04	6.4	1/4	3/8 - 24 UNF LH	66	36	11	250	36250	3.4	15.0
6YHLX-9-5C-PL	8	-05	7.9	5/16	9/16 - 18 UNF	80	36	16	138	20000	4.3	17.4
6YHLX-9-5C-PL-LH	8	-05	7.9	5/16	9/16 - 18 UNF LH	80	36	16	138	20000	4.3	17.4

Design Factor >2:1

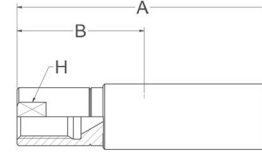

6HYLX – UNF female for water jetting nozzle



MATERIAL Stainless steel

NOTE ProLance fitting

Design Factor >2:1

#						A	B	H			Nipple ID	Ferrule OD
	DN	size	mm	inch					mm	psi		
6HYLX-4-2AC-PL	4	-025	4.0	5/32	1/4 - 28 UNF	51	19	9	301	43645	1.6	11.6
6HYLX-4-2AC-PL-LH	4	-025	4.0	5/32	1/4 - 28 UNF LH	51	19	9	301	43645	1.6	11.6
6HYLX-6-2AC-PL-LH	4	-025	4.0	5/32	3/8 - 24 UNF-LH	49	21	11	301	43645	1.6	11.6
6HYLX-4-3C-PL	5	-03	4.8	3/16	1/4 - 28 UNF	52	19	9	280	40600	2.1	12.5
6HYLX-4-3C-PL-LH	5	-03	4.8	3/16	1/4 - 28 UNF LH	52	19	9	280	40600	2.1	12.5
6HYLX-6-3C-PL	5	-03	4.8	3/16	3/8 - 24 UNF	56	23	11	250	36250	2.1	12.5
6HYLX-6-3C-PL-LH	5	-03	4.8	3/16	3/8 - 24 UNF LH	56	23	11	250	36250	2.1	12.5
6HYLX-6-4C-PL	6	-04	6.4	1/4	3/8 - 24 UNF	58	25	11	250	36250	3.4	15.0
6HYLX-6-4C-PL-LH	6	-04	6.4	1/4	3/8 - 24 UNF LH	58	25	11	250	36250	3.4	15.0
6HYLX-9-5C-PL	8	-05	7.9	5/16	9/16 - 18 UNF	72	28	17	138	20000	4.3	17.4
6HYLX-9-5C-PL-LH	8	-05	7.9	5/16	9/16 - 18 UNF	72	28	17	138	20000	4.3	17.4

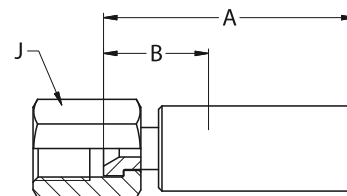
66YLX – High pressure female swivel**MATERIAL** Stainless steel

#						A	B			Nipple ID	Ferrule OD	
	DN	size	mm	inch								mm
66YLX-4-3	5	-03	4.8	3/16	9/16 - 18 UNF	71	33	19	180	26100	2.1	15.0

Design Factor >2:1

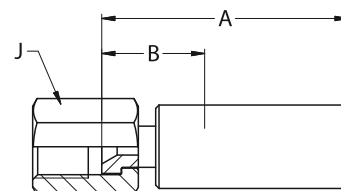
65YLX – Medium pressure female swivel**MATERIAL** Special materials, C: Stainless steel

#						A	B			Nipple ID	Ferrule OD	
	DN	size	mm	inch								mm
65YLX-6-3C	5	-03	4.8	3/16	9/16 - 18	78	39	19	138	20000	2.1	15.0
65YLX-6-4C	6	-04	6.4	1/4	9/16 - 18	72	39	19	138	20000	3.4	15.6

Hoses with design factor >2:1

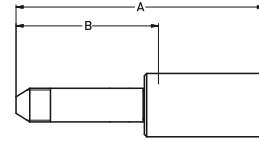

1Y2LX

1Y2LX – Medium pressure tube nipple



MATERIAL Special materials, C: Stainless steel

Design Factor >2:1

#						A	B			Nipple ID	Ferrule OD
	DN	size	mm	inch				MPa	psi		
1Y2LX-6-025	4	-025	4.0	5/32	3/8 - 24UNF-LH	112	65	138	20000	1.4	14.6
1Y2LX-6-03	5	-03	4.8	3/16	3/8 - 24UNF-LH	118	65	138	20000	1.4	15.3
1Y2LX-6-03C	5	-03	4.8	3/16	3/8 - 24UNF-LH	118	65	138	20000	1.4	15.3
1Y2LX-9-03	5	-03	4.8	3/16	9/16-18 UNF	102	65	138	20000	2.1	15.3
1Y2LX-9-03C	5	-03	6.4	1/4	9/16-18 UNF	102	65	138	20000	2.1	15.3
1Y2LX-6-04	6	-04	6.4	1/4	3/8 - 24UNF-LH	120	65	138	20000	2.9	17.0
1Y2LX-6-04C	6	-04	6.4	1/4	3/8 - 24UNF-LH	109	65	138	20000	2.9	17.0
1Y2LX-6-05C	8	-05	7.9	5/16	3/8-24 UNF LH	133	88	138	20000	3.7	21.0
1Y2LX-9-05	8	-05	7.9	5/16	9/16 - 18 UNF LH	105	60	138	20000	3.7	21.0
1Y2LX-6-06C	10	-06	9.5	3/8	3/8-24 UNF LH	128	82	138	20000	5.8	26.9
1Y2LX-9-06C	10	-06	9.5	3/8	9/16 - 18 UNF LH	137	91	138	20000	5.8	26.9
1Y2LX-9-08	12	-08	12.7	1/2	9/16 - 18 UNF LH	110	60	138	20000	6.7	30.7
1Y2LX-9-08C	12	-08	12.7	1/2	9/16 - 18 UNF LH	110	60	138	20000	6.7	30.7
1Y2LX-12-08C	12	-08	12.7	1/2	3/4 - 16 UNF LH	158	104	138	20000	6.7	30.7
1Y2LX-12-12C4462	20	-12	19.0	3/4	3/4 - 16 UNF LH	160	100	138	20000	12.7	38.5
1Y2LX-16-12C4462	20	-12	19.0	3/4	1-14 UNS LH	181	121	138	20000	11.7	38.5
1Y2LX-16-16C4462	25	-16	25.4	1	1-14 UNS LH	181	121	138	20000	17.2	45.3

2448D-TOUGH COVER – Ultra-high pressure hose**CONSTRUCTION**







Core tube : Polyoxymethylene
Pressure reinforcement : Four spiral layers of maximum tensile steel wire

Cover : Polyamide
Standard colour : blue

TEMPERATURE RANGE

-10°C up to +70°C

Design Factor >2:1

#													
	DN	size	mm	inch	mm	MPa	psi	MPa	psi	mm	kg/m		
2448D-025V32-TC	4	-025	4.0	5/32	9.9	301	43640	650	94240	100	0.21		

**NOTES**

Hoses with design factor >2:1
6YHLX – 6HYLX

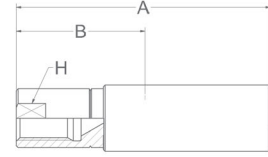

6YHLX – UNF male nozzle nipple



MATERIAL Stainless steel

NOTE ProLance fitting

Design Factor >2:1

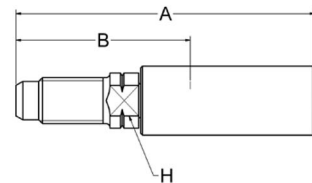

#						A	B	R			Nipple ID mm	Ferrule OD mm
	DN	size	mm	inch		mm	mm	mm	MPa	psi		
6YHLX-4-2AC-PL	4	-025	4.0	5/32	1/4 - 28 UNF	58	26	8	301	43645	1.6	11.6
6YHLX-4-2AC-PL-LH	4	-025	4.0	5/32	1/4 - 28 UNF LH	58	26	8	301	43645	1.6	11.6
6YHLX-6-2AC-PL-LH	4	-025	4.0	5/32	3/8-24 UNF LH	62	30	10	301	43645	1.6	11.6

6HYLX – UNF female for water jetting nozzle



MATERIAL Stainless steel

NOTE *ProLance fitting

#						A	B	R			Nipple ID mm	Ferrule OD mm
	DN	size	mm	inch		mm	mm	mm	MPa	psi		
6HYLX-4-2AC-PL	4	-025	4.0	5/32	1/4 - 28 UNF	51	19	9	301	43645	1.6	11.6
6HYLX-4-2AC-PL-LH	4	-025	4.0	5/32	1/4 - 28 UNF LH	51	19	9	301	43645	1.6	11.6
6HYLX-6-2AC-PL-LH	4	-025	4.0	5/32	3/8 - 24 UNF-LH	49	21	11	301	43645	1.6	11.6

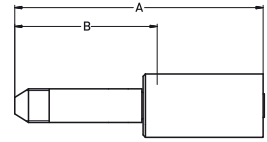
**6Y4LX – High pressure tube nipple
UNF – LH thread****MATERIAL** Stainless steel

#						A	B			Nipple ID	Ferrule OD
	DN	size	mm	inch				MPa	psi		
6Y4LX-4-2AC	4	-025	4.0	5/32	1/4 - 28UNF-LH	75	44	400	58000	1.6	14.4
6Y4LX-6-2AC	4	-025	4.0	5/32	3/8 - 24UNF-LH	86	55	400	58000	1.6	14.4

Design Factor >2:1

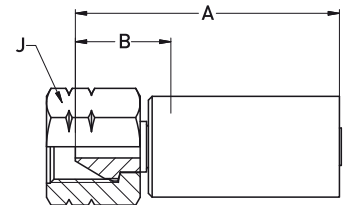
6AYLX – Type “M” female swivel**MATERIAL** Stainless steel

#						A	B				Nipple ID	Ferrule OD
	DN	size	mm	inch					MPa	psi		
6AYLX-6-2AC	4	-025	4.0	5/32	9/16 - 18 UNF	64	33	17	301	43645	1.6	14.4

2640D / 2640N – Ultra-high pressure hose









CONSTRUCTION

Core tube : DN 4-6: Polyoxymethylene; DN 12-25: Polyamide
Pressure reinforcement : Six spiral layers of maximum tensile steel wire

Cover : Polyamide
Standard colour : Blue

TEMPERATURE RANGE -10°C up to +70°C

Design Factor >2:1

#												
	DN	size	mm	inch	mm	MPa	psi	MPa	psi	mm	kg/m	
2640D-03V32	5	-03	4.8	3/16	13.0	250	36250	625	90625	175	0.41	
2640D-04V32	6	-04	6.4	1/4	14.6	250	36250	625	90625	200	0.64	
2640N-08V32	12	-08	12.8	1/2	24.5	180	26100	450	65250	290	1.36	
2640N-12V32	20	-12	19.6	3/4	33.0	140	20300	350	50750	350	2.10	
2640N-16V32	25	-16	25.0	1	40.0	120	17400	300	43500	400	2.90	

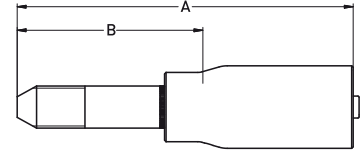

NOTES

**1Y42X – High pressure tube nipple
UNF – LH thread****MATERIAL** Nipple: very high strength stainless steel

Shell: high strength carbon steel, zinc plated, C-stainless steel

#	⊙				📏	A	B	↗		Nipple ID	Ferrule OD
	DN	size	mm	inch				MPa	psi		
1Y42X-4-03	5	-03	4.8	3/16	1/4 - 28UNF-LH	116	63	400	58000	2.3	18.6
1Y42X-4-03C	5	-03	4.8	3/16	1/4 - 28UNF-LH	116	63	400	58000	2.3	18.6
1Y42X-6-03	5	-03	4.8	3/16	3/8 - 24UNF-LH	116	63	400	58000	2.3	18.6
1Y42X-6-03C	5	-03	4.8	3/16	3/8 - 24UNF-LH	116	63	400	58000	2.3	18.6
1Y42X-9-03	5	-03	4.8	3/16	9/16 - 18UNF-LH	116	63	400	58000	2.3	18.6
1Y42X-9-03C	5	-03	4.8	3/16	9/16 - 18UNF-LH	116	63	400	58000	2.3	18.6
1Y42X-6-04	6	-04	6.4	1/4	3/8 - 24UNF-LH	116	63	400	58000	3.1	19.1
1Y42X-9-04	6	-04	6.4	1/4	9/16 - 18UNF-LH	116	63	400	58000	3.1	19.1
1Y42X-9-08	12	-08	12.7	1/2	9/16-18 UNF LH	139	73	400	58000	7.0	31.7
1Y42X-16-08	12	-08	12.7	1/2	1-14 UNS LH	148	78	300	43500	7.0	31.7

Design Factor >2:1

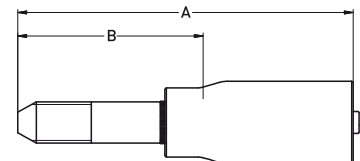
**1YM2X / 1YMJX – High pressure tube nipple
metric – LH thread****MATERIAL** Nipple: very high strength stainless steel

Shell: high strength carbon steel, zinc plated, C-stainless steel

#	⊙				📏	A	B	↗		Nipple ID	Ferrule OD
	DN	size	mm	inch				MPa	psi		
1YM2X-6-03	5	-03	4.8	3/16	M14x1.5-LH	116	63	400	58000	2.3	18.6
1YM2X-6-03C	5	-03	4.8	3/16	M14x1.5-LH	116	63	400	58000	2.3	18.6
1YM2X-6-04	6	-04	6.4	1/4	M14x1.5-LH	116	63	400	58000	3.1	19.1
1YMJX-11-08	12	-08	12.7	1/2	M18x1,5 LH	148	78	300	43500	7.0	31.7
1YMJX-12-08	12	-08	12.7	1/2	M20x1,5 LH	148	78	300	43500	7.0	31.7

Hoses with design factor >2:1



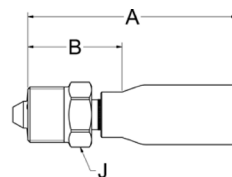

1YX2X - 1YY2X

1YX2X – High pressure swivel fitting UNF Rotatable under pressure



MATERIAL Nipple: very high strength stainless steel

Shell: high strength carbon steel, zinc plated - Gland nut: stainless steel



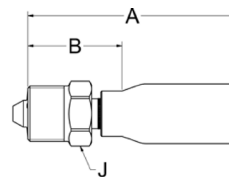

#						A	B				Nipple ID	Ferrule OD
	DN	size	mm	inch					MPa	psi		
1YX2X-6-03	5	-03	4.8	3/16	3/4-16 UNF	95	45	22	400	58000	2.3	18.6
1YX2X-9-03	5	-03	4.8	3/16	1 1/8-12 UNF	98	48	30	400	58000	2.3	18.6

1YY2X – High pressure swivel fitting metric Rotatable under pressure



MATERIAL Nipple: very high strength stainless steel

Shell: high strength carbon steel, zinc plated - Gland nut: stainless steel

#						A	B				Nipple ID	Ferrule OD
	DN	size	mm	inch					MPa	psi		
1YY2X-6-03	5	-03	4.8	3/16	M20x1,5	95	45	22	400	58000	2.3	18.6
1YY2X-9-03	5	-03	4.8	3/16	M26x1,5	98	48	27	400	58000	2.3	18.6
1YY2X-10-03	5	-03	4.8	3/16	M30x2	98	48	32	400	58000	2.3	18.6

Design Factor >2:1

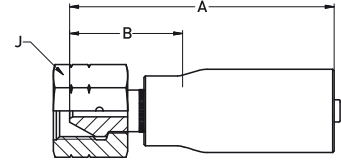
1AY2X / 1AYJX – Type “M” female swivel**MATERIAL** Nipple: very high strength stainless steel

Shell and nut: high strength carbon steel, zinc plated, C-stainless steel

#	⊙				⌚	A	B	J	↗	Nipple ID	Ferrule OD	
	DN	size	mm	inch								mm
1AY2X-6-03	5	-03	4.8	3/16	9/16 - 18UNF	91	38	22	400	58000	2.3	18.6
1AY2X-6-03C	5	-03	4.8	3/16	9/16 - 18UNF	91	38	22	400	58000	2.3	18.6
1AY2X-6-04	6	-04	6.4	1/4	9/16-18 UNF	91	38	22	400	58000	3.1	19.1
1AY2X-11-08	12	-08	12.7	1/2	1-12 UNF	107	37	32	301	43645	7.0	31.7
1AY2X-11-08C	12	-08	12.7	1/2	1-12 UNF	107	37	32	301	43645	7.0	31.7
1AYJX-16-12W	20	-12	19.0	3/4	1 5/16-12UNF	90	31	41	160	23200	12.5	40.6
1AYJX-16-12C	20	-12	19.0	3/4	1 5/16-12UNF	90	31	41	160	23200	12.5	40.6

Design Factor >2:1

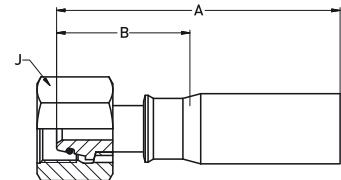
1C92X / 1C9JX – Metric female swivel heavy series with O-ring**MATERIAL** Nipple: very high strength stainless steel

Shell and nut: high strength carbon steel, zinc plated, C-stainless steel

#	⊙				⌚	A	B	J	↗	Nipple ID	Ferrule OD	
	DN	size	mm	inch								mm
1C92X-16-08	12	-08	12.7	1/2	M24x1,5	117	47	32	301	43645	7.0	31.7
1C92X-16-08C	12	-08	12.7	1/2	M24x1,5	117	47	32	301	43645	7.0	31.7
1C9JX-25-12W	20	-12	19.0	3/4	M36x2	108	49	46	160	23200	12.5	40.6
1C9JX-25-12C	20	-12	19.0	3/4	M36x2	108	49	46	160	23200	12.5	40.6
1C9JX-30-16W	25	-16	25.4	1	M42x2	121	55	55	150	21750	17.3	49.0

Hoses with design factor >2:1

1922X – 16Y2X – 1Y2JX

1922X – BSP female swivel (60° cone)

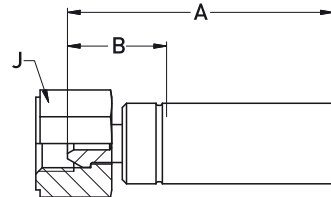

MATERIAL Nipple: very high strength carbon steel, zinc plated to nipple very high strength stainless steel
Shell and nut: high strength carbon steel, zinc plated, C-stainless steel

#	Nipple				A	B	J	Pressure		Nipple ID	Ferrule OD
	DN	size	mm	inch				MPa	psi		
1922X-4-03	5	-03	4.8	3/16	79	26	22	300	43500	2.3	18.6

Design Factor >2:1

16Y2X – High pressure female swivel

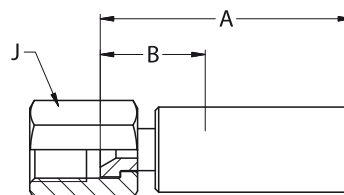

MATERIAL Nipple: very high strength stainless steel
Shell and nut: high strength carbon steel, zinc plated, C-stainless steel

#	Nipple				A	B	J	Pressure		Nipple ID	Ferrule OD
	DN	size	mm	inch				MPa	psi		
16Y2X-4-03	5	-03	4.8	3/16	76	23	19	300	43500	2.3	18.6

1Y2JX – Medium pressure tube nipple

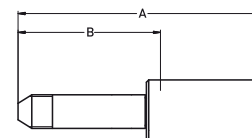

MATERIAL Nipple: very high strength stainless steel
Shell: high strength carbon steel, zinc plated, C-stainless steel

#	Nipple				A	B	Pressure		Nipple ID	Ferrule OD
	DN	size	mm	inch			MPa	psi		
1Y2JX-16-12	20	-12	19.0	3/4	133	70	138	20000	12.5	40.6
1Y2JX-16-12C	20	-12	19.0	3/4	133	70	138	20000	12.5	40.6
1Y2JX-16-16W	25	-16	25.4	1	146	70	138	20000	17.3	49.0

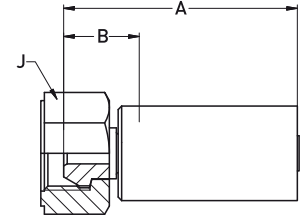
1MR2X – Metric female swivel 59° cone**MATERIAL** High strength carbon steel, zinc plated

#						A	B			Nipple ID	Ferrule OD	
	DN	size	mm	inch								mm
1MR2X-6-03	5	-03	4.8	3/16	M12x1,5	116	63	17	400	58000	2.3	18.6
1MR2X-8-03	5	-03	4.8	3/16	M14x1.5	91	38	22	400	58000	2.3	18.6
1MR2X-10-03	5	-03	4.8	3/16	M16x1.5	91	38	22	400	58000	2.3	18.6
1MR2X-12-03	5	-03	4.8	3/16	M18x1.5	91	38	24	400	58000	2.3	18.6

Design Factor >2:1

1TM2X – Polyflex Lok components

#	Description
1TM2X-8-03-HPK	Fitting for DN5 hoses incl. caps (refer to chapter D)
1TM2X-9-08-HPK	Fitting for DN12 hoses incl. caps (refer to chapter D)





Hoses with design factor >2:1
 1C35X – 1C95X – 1AY5X

1C35X – Metric female swivel light series

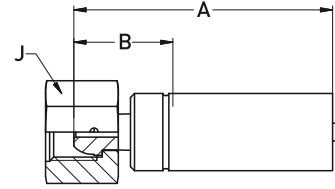
For hydraulic oil only

MATERIAL Nipple: very high strength carbon steel, zinc plated
 Shell and nut: high strength carbon steel, zinc plated







#						A	B				Nipple ID	Ferrule OD
	DN	size	mm	inch					MPa	psi		
1C35X-8-03	5	-03	4.8	3/16	M14x1.5	64	25	22	250	36250	1.7	19.1

1C95X – Metric female swivel heavy series with O-ring

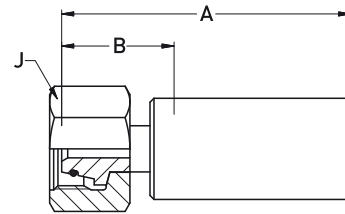
For hydraulic oil only

MATERIAL Nipple: very high strength carbon steel, zinc plated
 Shell and nut: high strength carbon steel, zinc plated







#						A	B				Nipple ID	Ferrule OD
	DN	size	mm	inch					MPa	psi		
1C95X-16-08	12	-08	12.7	1/2	M24x1.5	87	34	32	180	26100	6.7	34.1
1C95X-25-12	20	-12	19.0	3/4	M36x2	92	39	46	140	20300	12.7	41.8

1AY5X – Type “M” female swivel

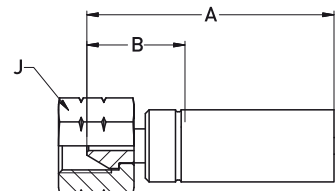
For hydraulic oil only

MATERIAL Nipple: very high strength carbon steel, zinc plated
 Shell and nut: high strength carbon steel, zinc plated



#						A	B				Nipple ID	Ferrule OD
	DN	size	mm	inch					MPa	psi		
1AY5X-6-03	5	-03	4.8	3/16	9/16 - 18UNF	66	26	22	250	36250	1.7	19.1
1AY5X-11-08	12	-08	12.7	1/2	1 - 12 UNF	80	27	32	180	26100	6.7	34.1
1AY5X-16-12	20	-12	19.0	3/4	1 5/16 - 12UNF	82	29	41	140	20300	12.7	41.8

Design Factor >2:1

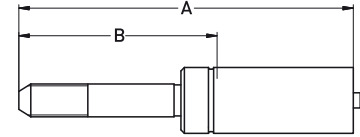
**1YA5X – High pressure tube nipple
UNF – LH thread****For hydraulic oil only****MATERIAL** Special materials

#						A	B			Nipple ID	Ferrule OD
	DN	size	mm	inch		mm	mm	MPa	psi		
1YA5X-1-03	5	-03	4.8	3/16	1/4 - 28UNF-LH	92	53	250	36250	1.3	19.1
1YA5X-3-03	5	-03	4.8	3/16	3/8 - 24UNF-LH	97	58	250	36250	1.3	19.1

Design Factor >2:1

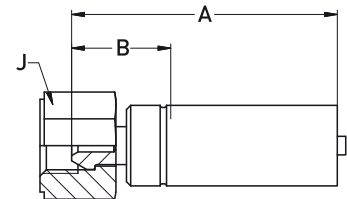
1925X – BSP female swivel (60° cone)**For hydraulic oil only****MATERIAL** Nipple: very high strength carbon steel, zinc plated
Shell and nut: high strength carbon steel, zinc plated

#						A	B	J			Nipple ID	Ferrule OD
	DN	size	mm	inch		mm	mm	mm	MPa	psi		
1925X-4-03	5	-03	4.8	3/16	G 1/4	78	32	22	250	36250	1.7	19.1

2648N – Ultra-high pressure hose









CONSTRUCTION

Core tube : Polyamide
 Pressure reinforcement : Six spiral layers of maximum tensile steel wire

Cover : Polyamide
 Standard colour : Blue

TEMPERATURE RANGE -10°C up to +70°C

Design Factor >2:1

#												
	DN	size	mm	inch	mm	MPa	psi	MPa	psi	mm	kg/m	
2648N-12V32	20	-12	19.8	3/4	33.7	160	23200	400	58000	350	2.28	
2648N-16V32	25	-16	25.0	1	40.8	150	21750	375	54375	400	3.10	

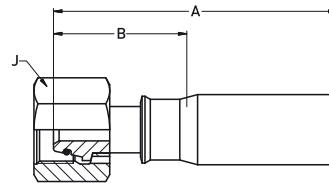

NOTES –

**1C9JX / 1C9CX – Metric female swivel
heavy series with O-ring**

MATERIAL Nipple: very high strength stainless steel
Shell and nut: high strength carbon steel, zinc plated

#	⊙				⋈	A	B	J	⊙		Nipple ID	Ferrule OD
	DN	size	mm	inch					MPa	psi		
1C9JX-25-12W	20	-12	19.0	3/4	M36x2	108	50	46	160	23200	12.5	40.6
1C9CX-30-16W	25	-16	25.4	1	M42x2	121	55	55	150	21750	17.3	49.0

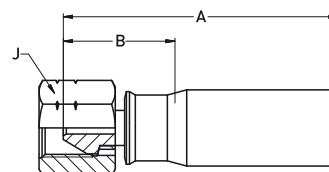
1AYJX / 1AYCX – Type “M” female swivel

MATERIAL Nipple: very high strength stainless steel
Shell and nut: high strength carbon steel, zinc plated

#	⊙				⋈	A	B	J	⊙		Nipple ID	Ferrule OD
	DN	size	mm	inch					MPa	psi		
1AYJX-16-12W	20	-12	19.0	3/4	1 5/16-12UNF	90	31	41	160	23200	12.5	40.6
1AYCX-16-16	25	-16	25.4	1	1 5/16-12UNF	146	72	41	138	20000	17.3	49.0

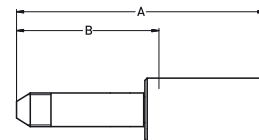
1Y2JX / 1Y2CX – Medium pressure tube nipple

MATERIAL Nipple: very high strength stainless steel
Shell: high strength carbon steel, zinc plated

#	⊙				⋈	A	B	⊙		Nipple ID	Ferrule OD
	DN	size	mm	inch				MPa	psi		
1Y2JX-16-12W	20	-12	19.0	3/4	1-14 UNS LH	133	75	138	20000	12.5	40.6
1Y2CX-16-16	25	-16	25.4	1	1-14 UNS LH	146	72	138	20000	17.3	49.0

Design Factor >2:1

Hoses with design factor >2:1
 PFX21 1Y2JX / 1Y2CX

PFX21 – Ultra-high pressure hose



CONSTRUCTION

Core tube : Polyoxymethylene

Pressure reinforcement : Four to six spiral layers of maximum tensile wire







Cover : Polyamide, silver alternatively with double cover ToughJACKET™

TEMPERATURE RANGE

-10°C up to +70°C

Design Factor >2:1

- TJ cover = double cover for extreme conditions with increased abrasion requirements ToughJACKET™
- Silver cover according WJTA Color Coding
- Hose in accordance with ISO 23384 and DIN EN 1829-2.

#														
	DN	size	mm	inch	mm	MPa	psi	MPa	psi	mm	kg/m			
PFX21-02	3	-02	3.0	1/8	7.9	210	30450	525	76125	100	0.12			
PFX21-03	5	-03	4.9	3/16	11.6	210	30450	525	76125	130	0.28			
PFX21-08	12	-08	13.0	3/16	27.1	210	30450	525	76125	300	1.85			
PFX21-08-TJ	12	-08	13.0	1/2	31.1	210	30450	525	76125	300	2.06			



**1Y42X – High pressure tube nipple
UNF – LH thread**

MATERIAL Nipple: very high strength stainless steel
Shell: high strength carbon steel, zinc plated

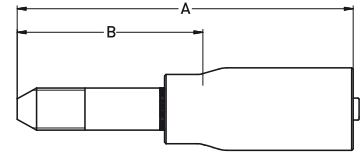

#	⊙				🌀	A	B	⊙		Nipple ID	Ferrule OD
	DN	size	mm	inch				MPa	psi		
1Y42X-9-08	12	-08	12.5	1/2	9/16 - 18 UNF-LH	139	73	400	58000	6.9	33.4
1Y42X-16-08	12	-08	12.5	1/2	1 - 14 UNF-LH	143	78	300	43500	6.9	33.4

**1YM2X – High pressure tube nipple
metric – LH thread**

MATERIAL Nipple: very high strength stainless steel
Shell: high strength carbon steel, zinc plated

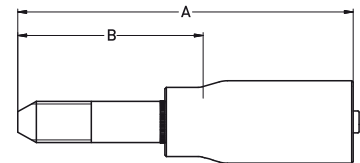

#	⊙				🌀	A	B	⊙		Nipple ID	Ferrule OD
	DN	size	mm	inch				MPa	psi		
1YM2X-6-08	12	-08	12.5	1/2	M14x1.5 - LH	139	73	400	58000	6.9	33.4
1YM2X-11-08	12	-08	12.5	1/2	M18x1.5-LH	143	78	300	43500	6.9	33.4
1YM2X-12-08	12	-08	12.5	1/2	M20x1.5-LH	143	78	300	43500	6.9	33.4

1AY2X – Type “M” female swivel

MATERIAL Nipple: very high strength stainless steel
Shell and nut: high strength carbon steel, zinc plated

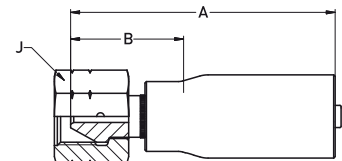

#	⊙				🌀	A	B	J	⊙		Nipple ID	Ferrule OD
	DN	size	mm	inch					MPa	psi		
1AY2X-11-08	12	-08	12.5	1/2	1-12 UNF	102	37	32	320	46400	6.9	33.4

Design Factor >2:1

Hoses with design factor >2:1
 1C92X – 1TM2X

1C92X – Metric female swivel heavy series with O-ring

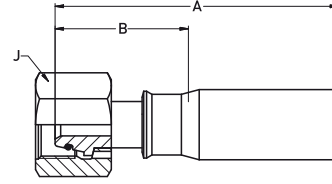

MATERIAL Nipple: very high strength stainless steel
 Shell and nut: high strength carbon steel, zinc plated

#						A	B				Nipple ID	Ferrule OD
	DN	size	mm	inch					MPa	psi		
1C92X-16-08	12	-08	12.5	1/2	M24x1.5	112	46	32	280	40600	6.9	33.4

Design Factor >2:1

1TM2X – Polyflex Lok components



#	Description
1TM2X-9-08-HPK	Fitting for DN12 hoses incl. caps (refer to chapter D)

PFX25 – 2.500 bar Ultra high-pressure hose



CONSTRUCTION

Core tube : Polyoxymethylene
Pressure reinforcement : Four to six spiral layers of maximum tensile wire







Cover : Polyamide, silver alternatively with double cover ToughJACKET™
Standard colour :

TEMPERATURE RANGE

-10°C up to +70°C

- TJ cover = double cover for extreme conditions with increased abrasion requirements ToughJACKET™
- Silver cover according WJTA Color Coding
- Hose in accordance with ISO 23384 and DIN EN 1829-2.

Design Factor >2:1

#													
	DN	size	mm	inch	mm	MPa	psi	MPa	psi	mm	kg/m		
PFX25-05	8	-05	7.8	5/16	18.0	250	36250	625	90625	200	0.85		
PFX25-05-TJ	8	-05	7.8	5/16	22.0	250	36250	625	90625	200	1.00		





Hoses with design factor >2:1
 1Y42X – 1YM2X - 1YY2X - 1YX2X

Design Factor >2:1

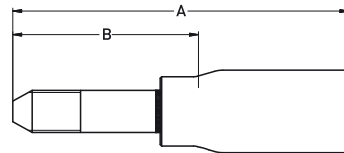
1Y42X – High pressure tube nipple UNF – LH thread





MATERIAL Nipple: very high strength stainless steel
 Shell: stainless steel

#						A	B			Nipple ID	Ferrule OD
	DN	size	mm	inch				MPa	psi		
1Y42X-6-05	8	-05	7.9	5/16	3/8 - 24UNF-LH	116	63	400	58000	3.7	22.0
1Y42X-9-05	8	-05	7.9	5/16	9/16-18 UNF LH	125	72	400	58000	3.7	22.0

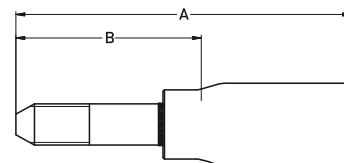
1YM2X – High pressure tube nipple metric – LH thread





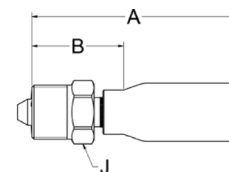

MATERIAL Nipple: very high strength stainless steel
 Shell: stainless steel

#						A	B			Nipple ID	Ferrule OD
	DN	size	mm	inch				MPa	psi		
1YM2X-6-05	8	-05	7.9	5/16	M14x1.5-LH	125	72	400	58000	3.7	22.0

1YY2X – High pressure tube nipple swivel fitting metric rotatable under pressure





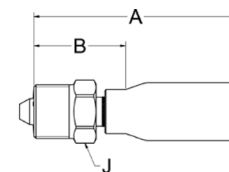

MATERIAL Nipple: very high strength stainless steel
 Shell and gland nut: stainless steel

#						A	B				Nipple ID	Ferrule OD
	DN	size	mm	inch					MPa	psi		
1YY2X-9-05	8	-05	7.9	5/16	M26x1.5	105	54.5	30	400	58000	3.7	22.0
1YY2X-10-05	8	-05	7.9	5/16	M30x2	105	54.5	32	400	58000	3.7	24.0

1YX2X – High pressure swivel fitting UNF rotatable under pressure



MATERIAL Nipple: very high strength stainless steel
 Shell and gland nut: stainless steel





#						A	B				Nipple ID	Ferrule OD
	DN	size	mm	inch					MPa	psi		
1YX2X-9-05	8	-05	7.9	5/16	1 1/8 - 12 UNF	105	54.5	30	400	58000	3.7	24.0

1AY2X – Type “M” female swivel**MATERIAL** Nipple: very high strength stainless steel

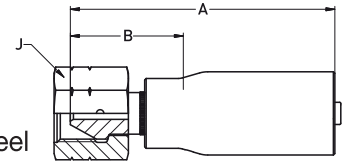
Shell: stainless steel

Nut: high strength carbon steel, zinc plated, C – stainless steel





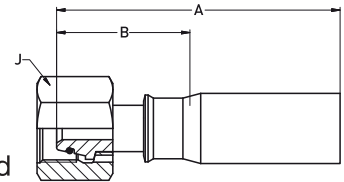

#						A	B			Nipple ID	Ferrule OD	
	DN	size	mm	inch		mm	mm	mm	MPa	psi	mm	mm
1AY2X-8-05	8	-05	7.9	5/16	3/4 - 16UNF	91	38	27	320	46400	3.7	22.0
1AY2X-10-05	8	-05	7.9	5/16	7/8 - 14UNF	91	38	30	320	46400	3.7	22.0
1AY2X-13-05	8	-05	7.9	5/16	1 1/8 - 12UNF	91	38	36	320	46400	3.7	22.0
1AY2X-13-05C	8	-05	7.9	5/16	1 1/8 - 12UNF	91	38	36	320	46400	3.7	22.0

1C92X – Metric female swivel heavy series with O-ring**MATERIAL** Nipple: very high strength stainless steel

Shell and nut: stainless steel, high strength carbon steel, zinc plated



#						A	B			Nipple ID	Ferrule OD	
	DN	size	mm	inch		mm	mm	mm	MPa	psi	mm	mm
1C92X-12-05	8	-05	7.9	5/16	M20x1.5	91	38	27	280	40600	3.7	22.0

1TM2X – Polyflex Lok components

#	Description
1TM2X-8-05-HPK	Fitting for DN8 hoses incl. caps (refer to chapter D)

Design Factor >2:1

Hoses with design factor >2:1
 PFX30

PFX30 – 3000 bar Ultra-high pressure hose

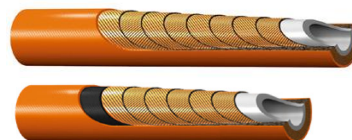

CONSTRUCTION

Core tube : Polyoxymethylene
Pressure reinforcement : Six to eight spiral layers of maximum tensile wire

Cover : Polyamide, orange alternatively with double cover
Standard colour : ToughJACKET™

TEMPERATURE RANGE -10°C up to +70°C

- TJ cover = double cover for extreme conditions with increased abrasion requirements ToughJACKET™
- Orange cover according WJTA Color Coding
- Hose in accordance with ISO 23384 and DIN EN 1829-2.

Design Factor >2:1

#	Ø				Ø		↗		↗		↘	kg/m
	DN	size	mm	inch	mm	MPa	psi	MPa	psi	mm		
PFX30-025	4	-025	4.0	5/32	12,0	301	43645	700	101500	140	0.29	
PFX30-03	5	-03	4.8	3/16	13,3	301	43645	700	101500	200	0.47	
PFX30-03-TJ	5	-03	4.8	3/16	17,3	301	43645	700	101500	200	0.58	
PFX30-05	8	-05	7.8	5/16	18.7	301	43645	700	101500	230	0.96	
PFX30-05-TJ	8	-05	7.8	5/16	22.7	301	43645	700	101500	230	1.11	
PFX30-06	10	-06	9.85	3/8	22.7	301	43645	625	90625	250	1.35	
PFX30-06-TJ	10	-06	9.85	3/8	26.7	301	43644	625	90625	250	1.53	
PFX30-08	12	-08	12.5	1/2	29.9	301	43645	625	90625	350	2.48	
PFX30-08-TJ	12	-08	12.5	1/2	34.0	301	43645	625	90625	350	2.72	



NOTES

1Y42X – High pressure tube nipple UNF – LH thread

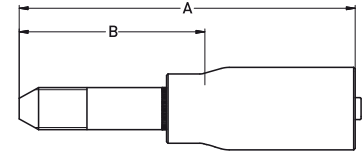

MATERIAL Nipple: very high strength stainless steel

Shell: high strength carbon steel, zinc plated, C-stainless steel

#	⊙				🌀	A	B	↻		Nipple ID	Ferrule OD
	DN	size	mm	inch				MPa	psi		
1Y42X-4-025	4	-025	4.0	5/32	1/4 - 28UNF-LH	88	45	400	58000	1.9	15.6
1Y42X-4-025C	4	-025	4.0	5/32	1/4 - 28UNF-LH	88	45	400	58000	1.9	15.6
1Y42X-6-025	4	-025	4.0	5/32	3/8 - 24UNF-LH	98	55	400	58000	1.9	15.6
1Y42X-6-025C	4	-025	4.0	5/32	3/8 - 24UNF-LH	98	55	400	58000	1.9	15.6
1Y42X-4-03	5	-03	4.8	3/16	1/4 - 28UNF-LH	116	63	400	58000	2.3	18.6
1Y42X-4-03C	5	-03	4.8	3/16	1/4 - 28UNF-LH	116	63	400	58000	2.3	18.6
1Y42X-6-03	5	-03	4.8	3/16	3/8 - 24UNF-LH	116	63	400	58000	2.3	18.6
1Y42X-6-03C	5	-03	4.8	3/16	3/8 - 24UNF-LH	116	63	400	58000	2.3	18.6
1Y42X-9-03	5	-03	4.8	3/16	9/16 - 18UNF-LH	116	63	400	58000	2.3	18.6
1Y42X-6-05	8	-05	7.9	5/16	3/8 - 24UNF-LH	116	63	400	58000	3.7	22.0
1Y42X-9-06	10	-06	9.9	3/8	9/16-18 UNF LH	130	72	400	58000	5.1	27.3
1Y42X-9-08	12	-08	12	1/2	9/16 - 18 UNF - LH	139	73	400	58000	6.9	33.4
1Y42X-16-08	12	-08	12	1/2	1 - 14 UNS - LH	143	77.5	300	43500	6.9	33.4
1Y42X-9-03C	5	-03	4.8	3/16	9/16 - 18UNF-LH	116	63	400	58000	2.3	18.6

Design Factor >2:1

1YM2X – High pressure tube nipple metric – LH thread

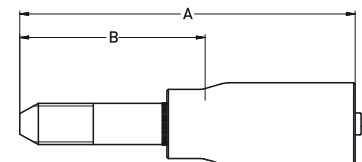

MATERIAL Nipple: very high strength stainless steel

Shell: high strength carbon steel, zinc plated, C-stainless steel

#	⊙				🌀	A	B	↻		Nipple ID	Ferrule OD
	DN	size	mm	inch				MPa	psi		
1YM2X-6-025	4	-025	4.0	5/32	M14x1.5-LH	108	55	400	58000	1.9	15.6
1YM2X-6-03	5	-03	4.8	3/16	M14x1.5-LH	116	63	400	58000	2.3	18.6
1YM2X-6-03C	5	-03	4.8	3/16	M14x1.5-LH	116	63	400	58000	2.3	18.6

Hoses with design factor >2:1

1YX2X - 1YY2X - 1AY2X

1YX2X – High pressure swivel fitting UNF Rotatable under pressure

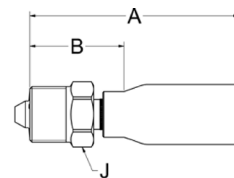

MATERIAL Nipple: very high strength stainless steel

Shell: high strength carbon steel, zinc plated - Gland nut: stainless steel

#	Nipple				Thread	A	B	J	Pressure		Nipple ID	Ferrule OD
	DN	size	mm	inch					MPa	psi		
1YX2X-6-03	5	-03	4.8	3/16	3/4-16 UNF	95	45	22	400	58000	2.3	18.6

Design Factor >2:1

1YY2X – High pressure swivel fitting UNF Rotatable under pressure

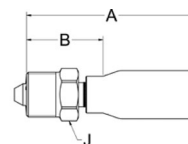

MATERIAL Nipple: very high strength stainless steel

Shell: high strength carbon steel, zinc plated - Gland nut: stainless steel

#	Nipple				Thread	A	B	J	Pressure		Nipple ID	Ferrule OD
	DN	size	mm	inch					MPa	psi		
1YY2X-6-025	4	-025	4.0	5/32	M20x1,5	91	47	22	400	58000	1.9	15.6
1YY2X-6-03	5	-03	4.8	3/16	M20x1,5	95	45	22	400	58000	2.3	18.6
1YY2X-9-03	5	-03	4.8	3/16	M26x1,5	98	48	27	400	58000	2.3	18.6
1YY2X-10-03	5	-03	4.8	3/16	M30x2	98	48	32	400	58000	2.3	18.6

1AY2X – Type “M” female swivel

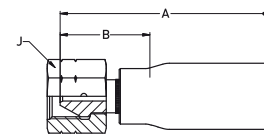

MATERIAL Nipple: very high strength stainless steel

Shell and nut: high strength carbon steel, zinc plated, C-stainless steel

#	Nipple				Thread	A	B	J	Pressure		Nipple ID	Ferrule OD
	DN	size	mm	inch					MPa	psi		
1AY2X-6-025	4	-025	4.0	5/32	9/16 - 18UNF	61	24	22	400	58000	1.9	15.6
1AY2X-6-025C	4	-025	4.0	5/32	9/16 - 18UNF	61	24	22	400	58000	1.9	15.6
1AY2X-6-03	5	-03	4.8	3/16	9/16 - 18UNF	91	38	22	400	58000	2.3	18.6
1AY2X-6-03C	5	-03	4.8	3/16	9/16 - 18UNF	91	38	22	400	58000	2.3	18.6

1922X – BSP female swivel (60° cone)

MATERIAL Nipple: very high strength carbon steel, zinc plated
Shell and nut: high strength carbon steel, zinc plated,
C-stainless steel

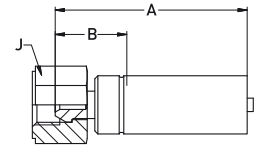

#	⊙				⋈	A	B	J	⊙		Nipple ID	Ferrule OD
	DN	size	mm	inch					MPa	psi		
1922X-4-03	5	-03	4.8	3/16	G 1/4	79	26	22	300	43500	2.3	18.6
1922X-4-025	4	-025	4.0	5/32	G 1/4	70	26	22	300	43500	1.9	15.6

16Y2X – High pressure female swivel

MATERIAL Nipple: very high strength stainless steel
Shell and nut: high strength carbon steel, zinc plated, C-stainless steel

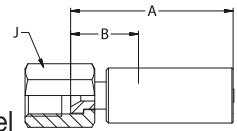

#	⊙				⋈	A	B	J	⊙		Nipple ID	Ferrule OD
	DN	size	mm	inch					MPa	psi		
16Y2X-4-03	5	-03	4.8	3/16	9/16 - 18UNF	76	23	19	300	43500	2.3	18.6
16Y2X-4-025	4	-025	4	5/32	9/16 - 18UNF	76	23	19	300	43500	1.9	15.6
16Y2X-4-025C	4	-025	4	5/32	9/16 - 18UNF	76	23	19	300	43500	1.9	15.6

1MR2X – Metric female swivel 59° cone

MATERIAL High strength carbon steel, zinc plated

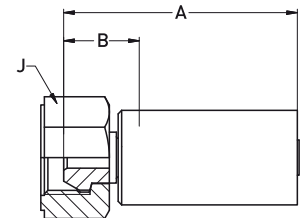

#	⊙				⋈	A	B	J	⊙		Nipple ID	Ferrule OD
	DN	size	mm	inch					MPa	psi		
1MR2X-6-025	4	-025	4.0	5/32	M12x1,5	88	45	17	400	58000	1.9	15.6
1MR2X-8-025	4	-025	4.0	5/32	M14x1,5	61	24	22	400	58000	1.9	15.6
1MR2X-10-025	4	-025	4.0	5/32	M16x1,5	61	24	22	400	58000	1.9	15.6
1MR2X-6-03	5	-03	4.8	3/16	M12x1,5	116	63	17	400	58000	2.3	18.6
1MR2X-8-03	5	-03	4.8	3/16	M14x1.5	91	38	22	400	58000	2.3	18.6
1MR2X-10-03	5	-03	4.8	3/16	M16x1.5	91	38	22	400	58000	2.3	18.6
1MR2X-12-03	5	-03	4.8	3/16	M18x1.5	91	38	24	400	58000	2.3	18.6

Design Factor >2:1

Hoses with design factor >2:1

1AY2X – 1C92X

1AY2X – Type “M” female swivel

MATERIAL Nipple: very high strength stainless steel

Shell: DN8 stainless steel, all others high strength carbon steel, zinc plated

Nut: high strength carbon steel, zinc plated, C-stainless steel

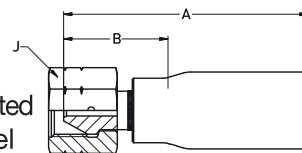

#	⊙				🌀	A	B	J	↻		Nipple ID	Ferrule OD
	DN	size	mm	inch					MPa	psi		
1AY2X-8-05	8	-05	7.9	5/16	3/4 - 16UNF	91	38	27	320	46400	3.7	22.0
1AY2X-10-05	8	-05	7.9	5/16	7/8 - 14UNF	91	38	30	320	46400	3.7	22.0
1AY2X-13-05	8	-05	7.9	5/16	1 1/8 - 12UNF	91	38	36	320	46400	3.7	22.0
1AY2X-13-05C	8	-05	7.9	5/16	1 1/8 - 12UNF	91	38	36	320	46400	3.7	22.0
1AY2X-8-06	10	-06	9.9	3/8	3/4 - 16UNF	95	38	27	320	46400	5.1	27.3
1AY2X-11-08	12	-08	12	1/2	1 - 12 UNF	102	36.5	32	320	46400	6.9	33.4

Design Factor >2:1

1C92X – Metric female swivel heavy series with O-ring

MATERIAL Nipple: very high strength stainless steel

Shell: DN8 stainless steel, all others high strength carbon steel, zinc plated

Nut: high strength carbon steel, zinc plated

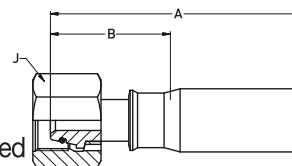

#	⊙				🌀	A	B	J	↻		Nipple ID	Ferrule OD
	DN	size	mm	inch					MPa	psi		
1C92X-12-05	8	-05	7.9	5/16	M20x1.5	91	38	27	280	40600	3.7	22.0
1C92X-12-06	10	-06	9.9	3/8	M20x1,5	95	38	27	301	46400	5.1	27.3
1C92X-16-06	10	-06	9.9	3/8	M24x1,5	95	38	32	301	46400	5.1	27.3
1C92X-16-08	12	-08	12	1/2	M24x1.5	112	46	32	280	40600	6.9	33.4

1YM2X – High pressure tube nipple metric – LH thread

MATERIAL Nipple: very high strength stainless steel

Shell: DN8 stainless steel, all others high strength carbon steel, zinc plated

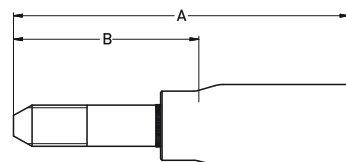

#	⊙				🌀	A	B	↻		Nipple ID	Ferrule OD
	DN	size	mm	inch				MPa	psi		
1YM2X-6-05	8	-05	7.9	5/16	M14x1.5-LH	125	72	400	58000	3.7	22.0
1YM2X-6-06	10	-06	9.9	3/8	M14x1,5 - LH	130	72	400	58000	5.1	27.3
1YM2X-11-08	12	-08	12.5	1/2	M18x1.5-LH	143	78	300	43500	6.9	33.4
1YM2X-12-08	12	-08	12.5	1/2	M20x1.5-LH	143	78	300	43500	6.9	33.4

1YX2X – High pressure swivel fitting UNF

rotatable under pressure

MATERIAL Nipple: very high strength stainless steel
Shell and gland nut: stainless steel

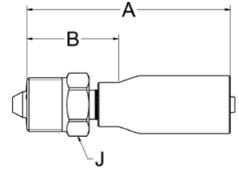

#						A	B			Nipple ID	Ferrule OD	
	DN	size	mm	inch								mm
1YX2X-9-05	8	-05	7.9	5/16	1 1/8-12 UNF	105	54.5	30	400	58000	3.7	24

Design Factor >2:1

1YY2X – High pressure tube nipple swivel fitting metric

rotatable under pressure

MATERIAL Nipple: very high strength stainless steel
Shell and gland nut: stainless steel

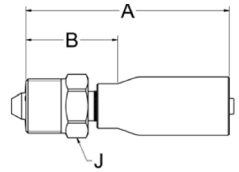

#						A	B			Nipple ID	Ferrule OD	
	DN	size	mm	inch								mm
1YY2X-9-05	8	-05	7.9	5/16	M26x1.5	105	54	30	400	58000	3.7	24
1YY2X-10-05	8	-05	7.9	5/16	M30x2	105	54.5	32	400	58000	3.7	24

Design Factor >2:1

1TM2X – Polyflex Lok components

#	Description
1TM2X-8-05-HPK	Fitting for DN8 hoses incl. caps (refer to chapter D)
1TM2X-9-08-HPK	Fitting for DN12 hoses incl. caps (refer to chapter D)

PFX38 – 3800 bar Ultra-high pressure hose

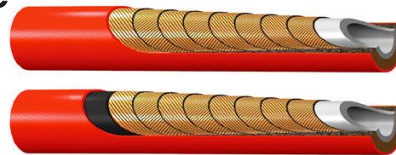







CONSTRUCTION

- Core tube** : Polyoxymethylene
- Pressure reinforcement** : Eight spiral layers of maximum tensile wire
- Cover** : Polyamide, red alternatively with double cover ToughJACKET™

TEMPERATURE RANGE -10°C up to +70°C

- TJ cover = double cover for extreme conditions with increased abrasion requirements ToughJACKET™
- Red cover according WJTA Color Coding
- Hose in accordance with ISO 23384 and DIN EN 1829-2.

Design Factor >2:1

#												
	DN	size	mm	inch	mm	MPa	psi	MPa	psi	mm	kg/m	
PFX38-05	8	-05	7.8	5/16	20.5	380	55100	760	110200	280	1.26	
PFX38-05-TJ	8	-05	7.8	5/16	24.5	380	55100	760	110200	280	1.43	



1AY2X – Type “M” female swivel**MATERIAL** Nipple: very high strength stainless steel

Shell: stainless steel

Nut: high strength carbon steel, zinc plated, C – stainless steel

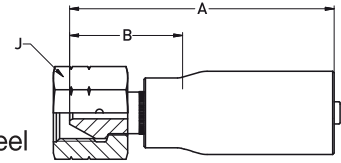

#						A	B				Nipple ID	Ferrule OD
	DN	size	mm	inch					MPa	psi		
1AY2X-8-05	8	-05	7.9	5/16	3/4 - 16UNF	91	38	27	320	46400	3.7	24.6
1AY2X-10-05	8	-05	7.9	5/16	7/8 - 14UNF	91	38	30	320	46400	3.7	24.6
1AY2X-13-05	8	-05	7.9	5/16	1 1/8 - 12UNF	91	38	36	320	46400	3.7	24.6
1AY2X-13-05C	8	-05	7.9	5/16	1 1/8 - 12UNF	91	38	36	320	46400	3.7	24.6

1C92X – Metric female swivel heavy series with O-ring**MATERIAL** Nipple: very high strength stainless steel

Shell and nut: stainless steel, high strength carbon steel, zinc plated

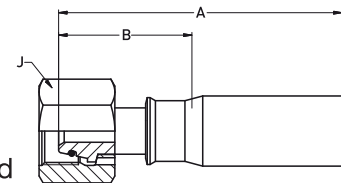

#						A	B				Nipple ID	Ferrule OD
	DN	size	mm	inch					MPa	psi		
1C92X-12-05	8	-05	7.9	5/16	M20x1.5	91	38	27	280	40600	3.7	24.6

1YM2X – High pressure tube nipple metric – LH thread**MATERIAL** Nipple: very high strength stainless steel

Shell: stainless steel

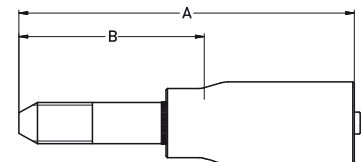

#						A	B			Nipple ID	Ferrule OD
	DN	size	mm	inch				MPa	psi		
1YM2X-6-05	8	-05	7.9	5/16	M14x1.5-LH	125	72	400	58000	3.7	24.6

1Y42X – High pressure tube nipple UNF – LH thread**MATERIAL** Nipple: very high strength stainless steel

Shell: stainless steel

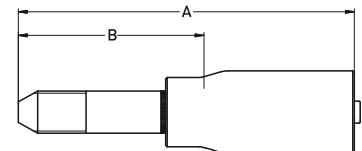

#						A	B			Nipple ID	Ferrule OD
	DN	size	mm	inch				MPa	psi		
1Y42X-6-05	8	-05	7.9	5/16	3/8 - 24UNF-LH	116	63	400	58000	3.7	24.6
1Y42X-9-05	8	-05	7.9	5/16	9/16-18 UNF LH	125	72	400	58000	3.7	24.6

Design Factor >2:1

Hoses with design factor >2:1





1YY2X – 1YX2X

1YX2X – High pressure swivel fitting UNF

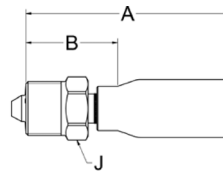
rotatable under pressure

MATERIAL Nipple: very high strength stainless steel
Shell and gland nut: stainless steel







#						A	B				Nipple ID	Ferrule OD
	DN	size	mm	inch					MPa	psi		
1YX2X-9-05	8	-05	7.9	5/16	1 1/8 - 12 UNF	105	54.5	30	400	58000	3.7	24.6

1YY2X – High pressure tube nipple swivel fitting metric

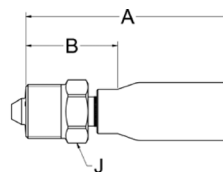
rotatable under pressure

MATERIAL Nipple: very high strength stainless steel
Shell and gland nut: stainless steel



#						A	B				Nipple ID	Ferrule OD
	DN	size	mm	inch					MPa	psi		
1YY2X-9-05	8	-05	7.9	5/16	M26x1.5	105	54.5	30	400	58000	3.7	24.6
1YY2X-10-05	8	-05	7.9	5/16	M30x2	105	54.5	32	400	58000	3.7	24.6

1TM2X – Polyflex Lok components



#	Description
1TM2X-8-05-HPK	Fitting for DN8 hoses incl. caps (refer to chapter D)

Design Factor >2:1

Hoses with design factor >2:1

Hoses with design factor >2:1

PFX40 - 4000 bar Ultra-high pressure hose1YX2X PFX40 - 4000 bar Ultra-high pressure hose1YX2X

PFX40 - 4000 bar Ultra-high pressure hose



CONSTRUCTION

Core tube : Polyoxymethylene
Pressure reinforcement : Eight spiral layers of maximum tensile steel wire







Cover : Polyamide, red
Standard colour : red

TEMPERATURE RANGE

-10°C up to +70°C

- Red cover according WJTA Color Coding
- Hose in accordance with ISO 23384 and DIN EN 1829-2
- TJ cover = double cover for extreme conditions with increased abrasion requirements ToughJACKETTM

Design Factor >2:1

#														
	DN	size	mm	inch	mm	MPa	psi	MPa	psi	mm	kg/m			
PFX40-03	5	-03	4.8	3/16	15.1	400	58000	800	116000	200	0.64			
PFX40-03-TJ	5	-03	4.8	3/16	19.1	400	58000	800	116000	200	0.77			



Hoses with design factor >2:1

1Y42X – 1YM2X

1Y42X – High pressure tube nipple UNF – LH thread

MATERIAL Nipple: very high strength stainless steel

Shell: high strength carbon steel, zinc plated, C-stainless steel

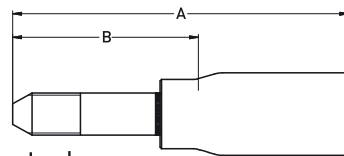

#	⊙				📏	A	B	⊙		Nipple ID	Ferrule OD
	DN	size	mm	inch				MPa	psi		
1Y42X-4-03	5	-03	4.8	3/16	1/4 - 28UNF-LH	116	63	400	58000	2.3	18.6
1Y42X-4-03C	5	-03	4.8	3/16	1/4 - 28UNF-LH	116	63	400	58000	2.3	18.6
1Y42X-6-03	5	-03	4.8	3/16	3/8 - 24UNF-LH	116	63	400	58000	2.3	18.6
1Y42X-6-03C	5	-03	4.8	3/16	3/8 - 24UNF-LH	116	63	400	58000	2.3	18.6
1Y42X-9-03	5	-03	4.8	3/16	9/16 - 18UNF-LH	116	63	400	58000	2.3	18.6
1Y42X-9-03C	5	-03	4.8	3/16	9/16 - 18UNF-LH	116	63	400	58000	2.3	18.6

Design Factor >2:1

1YM2X – High pressure tube nipple metric – LH thread

MATERIAL Nipple: very high strength stainless steel

Shell: high strength carbon steel, zinc plated, C-stainless steel

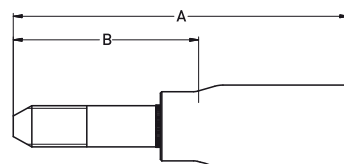

#	⊙				📏	A	B	⊙		Nipple ID	Ferrule OD
	DN	size	mm	inch				MPa	psi		
1YM2X-6-03	5	-03	4.8	3/16	M14x1.5-LH	116	63	400	58000	2.3	18.6
1YM2X-6-03C	5	-03	4.8	3/16	M14x1.5-LH	116	63	400	58000	2.3	18.6

1YX2X – High pressure swivel fitting UNF Rotatable under pressure

MATERIAL Nipple: very high strength stainless steel

Shell: high strength carbon steel, zinc plated - Gland nut: stainless steel

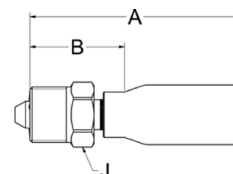

#	⊙				📏	A	B	J	⊙		Nipple ID	Ferrule OD
	DN	size	mm	inch					MPa	psi		
1YX2X-6-03	5	-03	4.8	3/16	3/4-16 UNF	95	45	22	400	58000	2.3	18.6

1YY2X – High pressure swivel fitting UNF

Rotatable under pressure

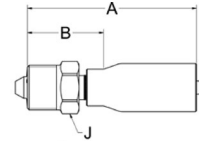

MATERIAL Nipple: very high strength stainless steel
Shell: high strength carbon steel, zinc plated - Gland nut: stainless steel

#	Nipple				Thread	A	B	J	Pressure	Nipple ID	Ferrule OD	
	DN	size	mm	inch								
1YY2X-6-03	5	-03	4.8	3/16	M20x1,5	95	45	22	400	58000	2.3	18.6
1YY2X-9-03	5	-03	4.8	3/16	M26x1,5	98	48	27	400	58000	2.3	18.6
1YY2X-10-03	5	-03	4.8	3/16	M30x2	98	48	32	400	58000	2.3	18.6

1AY2X – Type “M” female swivel

MATERIAL Nipple: very high strength stainless steel
Shell and nut: high strength carbon steel, zinc plated, C-stainless steel

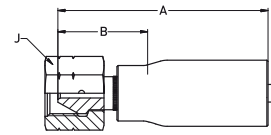

#	Nipple				Thread	A	B	J	Pressure	Nipple ID	Ferrule OD	
	DN	size	mm	inch								
1AY2X-6-03	5	-03	4.8	3/16	9/16 - 18UNF	91	38	22	400	58000	2.3	18.6
1AY2X-6-03C	5	-03	4.8	3/16	9/16 - 18UNF	91	38	22	400	58000	2.3	18.6

1922X – BSP female swivel (60° cone)

MATERIAL Nipple: very high strength carbon steel, zinc plated
Shell and nut: high strength carbon steel, zinc plated, C-stainless steel

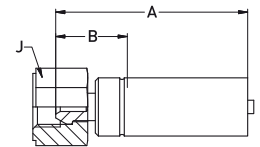

#	Nipple				Thread	A	B	J	Pressure	Nipple ID	Ferrule OD	
	DN	size	mm	inch								
1922X-4-03	5	-03	4.8	3/16	G 1/4	79	26	22	300	43500	2.3	18.6

16Y2X – High pressure female swivel

MATERIAL Nipple: very high strength stainless steel
Shell and nut: high strength carbon steel, zinc plated, C-stainless steel

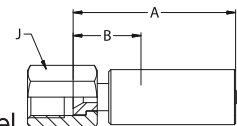

#	Nipple				Thread	A	B	J	Pressure	Nipple ID	Ferrule OD	
	DN	size	mm	inch								
16Y2X-4-03	5	-03	4.8	3/16	9/16 - 18UNF	76	23	19	300	43500	2.3	18.6

Hoses with design factor >2:1
1MR2X – 1YM2X

Hoses with design factor >2:1
1MR2X –

1MR2X – Metric female swivel 59° cone

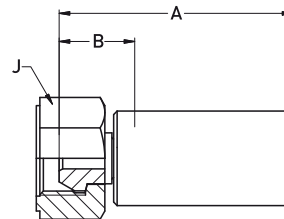

MATERIAL High strength carbon steel, zinc plated

Design Factor >2:1

#	⊙				⌚	A	B	J	⊙		Nipple ID	Ferrule OD
	DN	size	mm	inch					MPa	psi		
1MR2X-6-03	5	-03	4.8	3/16	M12x1,5	116	63	17	400	58000	2.3	18.6
1MR2X-8-03	5	-03	4.8	3/16	M14x1.5	91	38	22	400	58000	2.3	18.6
1MR2X-10-03	5	-03	4.8	3/16	M16x1.5	91	38	22	400	58000	2.3	18.6
1MR2X-12-03	5	-03	4.8	3/16	M18x1.5	91	38	24	400	58000	2.3	18.6

Chapter D

Polyflex-Lok

Polyflex-Lok D-2
Polyflex-Lok components D-5
Available hose types and Polyflex-Lok pressure rating D-6

Polyflex-Lok

21st century hose safety technology for today's demanding applications

Innovative design

Polyflex-Lok has been developed by Parker Polyflex to meet the requirements of today's water jetting applications. It uses the latest technology to provide a "state of the art" hose safety system. The hose connector as well as the pump/gun connector are now equipped with an improved design, based on the reliable quality of the former generation of Polyflex-Lok. The Polyflex-Lok hose assemblies are now also available without protective cover, and hose types with an additional outer cover for extra abrasion resistance and security are also available.

What is it?

Efficient and hassle free assembly – Quick connect & release hose connection system which also provides hose burst protection, while ranging in size from DN 5 (3/16") up to DN 12 (1/2"). One major benefit of the system is that it will only operate when full protection of the user is guaranteed. In addition, the Polyflex-Lok system is compliant with requirements determined in DIN EN 1829-2.

Product Features:

- Wide range of hose types available from 1,000 up to 3,200 bar working pressure
- Hose sizes available from DN 5 up to DN 12
- Certified according to DIN EN 1829-2
- Easy, fast, comfortable & safe system
- Only 2 working parts needed
- Integrated safety system
- No spanners required
- Incorrect assembly & use impossible
- Design factor 2.5 times (burst pressure)
- Mechanical design factor 4 times (hose connection breaking load)
- Same parts can be used to connect different hose series (e.g. DN 3 and DN 5)
- Swivel function when system is not under pressure (rotary joints)

Major Benefits:

- Operator protection guaranteed – priceless
- Hose twisting eliminated – longer hose life
- Faster assembly / disassembly of hoses – more valuable working time
- Less wear on components – fewer part replacements necessary
- Less operator fatigue due to easy handling & compact design – increases efficiency
- In one word: SAFETY!



System Overview Polyflex-Lok

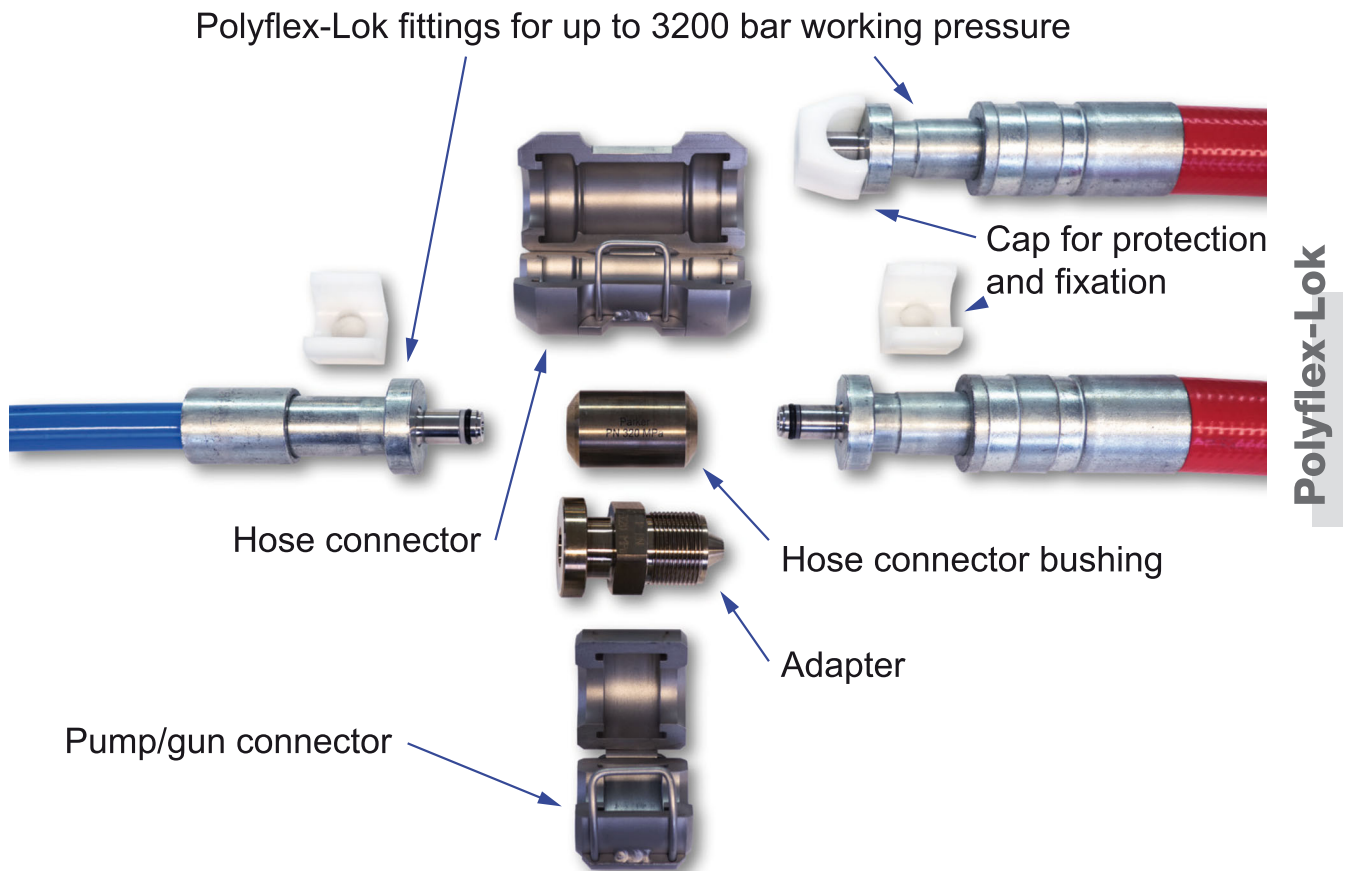

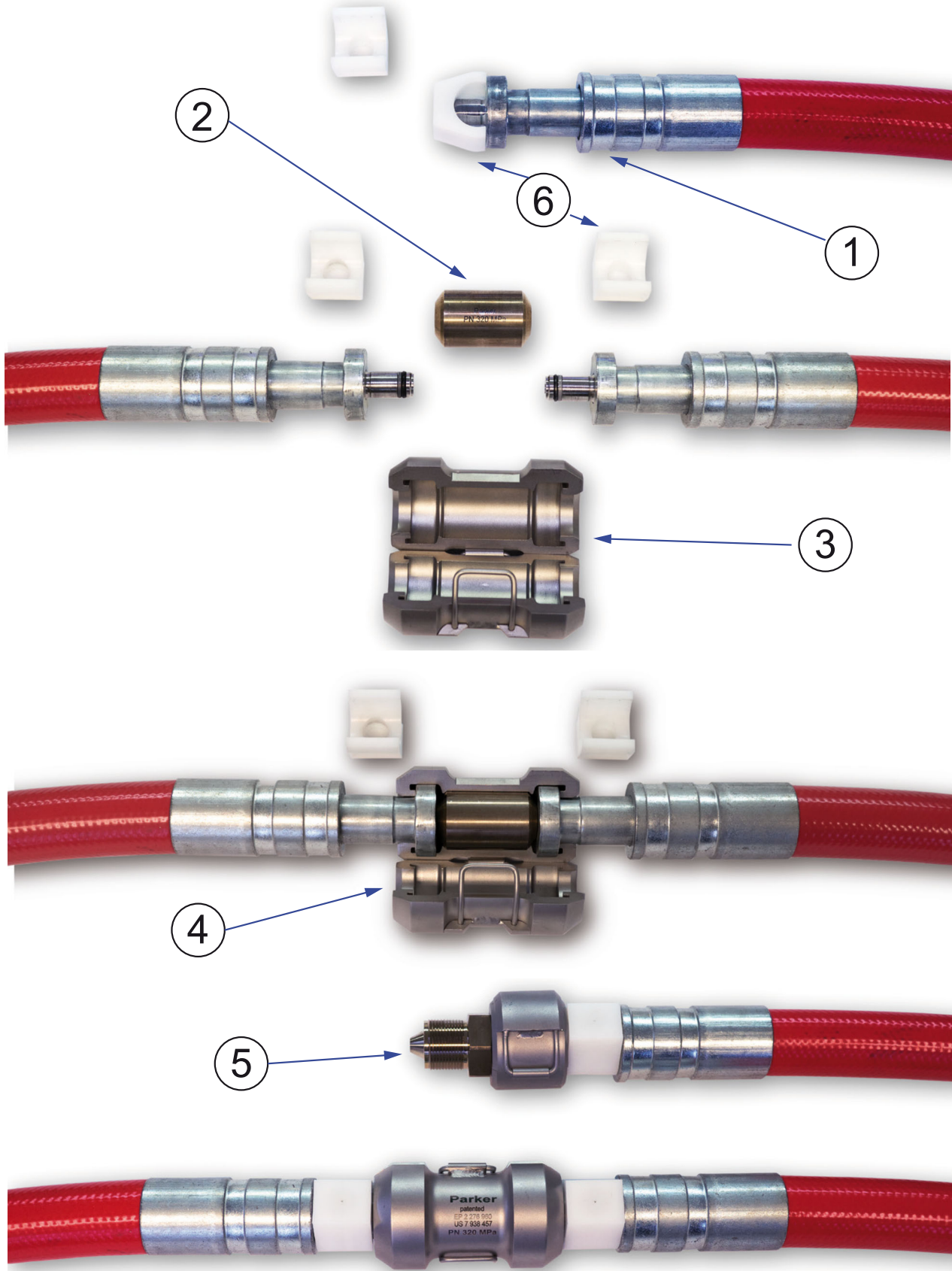

Polyflex-Lok components

Ref	Part Number	Description
1	1TM2X-8-03-HPK	Fitting for DN 5 hoses incl. caps
	1TM2X-8-05-HPK	Fitting for DN 8 hoses incl. caps
	1TMKY-8-05-HPK	Fitting for DN 8 hoses incl. caps
	1TMBL-9-08-HPK	Fitting for DN 12 hoses incl. caps
	1TMBS-9-08-HPK	Fitting for DN 12 hoses incl. caps
	1TM2X-9-08-HPK	Fitting for DN 12 hoses incl. caps
2	TFTF-8-8	Hose connector bushing for DN 5 and DN 8
	TFTF-8-9	Hose connector bushing - connection DN 5 or DN 8 to DN 12
	TFTF-9-9	Hose connector bushing for DN 12
3	HPK-HS-8	Hose connector
4	HPK-HSP-8	Pump/gun connector
5	YTTF-6-8	Adapter M20 x 1.5 to DN 5 or DN 8
	YTTF-9-8	Adapter M26 x 1.5 to DN 5 or DN 8
	YTTF-9-9	Adapter M26 x 1.5 to DN 12
	YTTF-10-8	Adapter M30 x 2 to DN 5 or DN 8
	YTTF-10-9	Adapter M30 x 2 to DN 12
	YTTF-12-8	Adapter M42 x 2 to DN 5 or DN 8
	YTTF-12-9	Adapter M42 x 2 to DN 12
	Y6TF-6-8	Adapter 3/4 - 16UNF to DN 5 or DN 8
	Y6TF-9-8	Adapter 1 1/8 - 12UNF to DN 5 or DN 8
Y6TF-9-9	Adapter 1 1/8 - 12UNF to DN 12	
6	TMCAP-8	Cap DN 5 or DN 8
	TMCAP-9	Cap DN 12

Available Hose Types and Polyflex-Lok Pressure Rating

Polyflex-Lok pressure rating for size -03/DN5:
3200 bar

Size	DN	Hose types
-03	DN5	2640D-03Vxx
		2740D-03Vxx
		2840D-03Vxx

Polyflex-Lok pressure rating for size -05/DN8:
3200 bar

Size	DN	Hose types
-05	DN8	2380N-05VxxW
		PFX25-05
		PFX25-05-TJ
		PFX30-05
		PFX30-05-TJ
		PFX38-05
		PFX38-05-TJ

Polyflex-Lok pressure rating for size -08/DN12:
2500 bar

Size	DN	Hose types
-08	DN12	2388N-08Vxx
		2580N-08Vxx
		2640N-08Vxx
		PFX21-08
		PFX21-08-TJ,
		PFX30-08
		PFX30-08-TJ

Chapter E**Accessories**

Heavy duty abrasion cover	E-2
Heavy duty abrasion cover sleeves	E-2
Spring guards.....	E-3
Support grips	E-3
PVC-S – Anti-abrasion sleeve.....	E-4
HS - Containment grips	E-4
UHPLABEL – Precautions for ultra-high pressure applications	E-4

Heavy duty abrasion cover



#	Description
MHDC010	5/8" I.D. Clear Vinyl
MHDC011	5/8" I.D. Clear Vinyl with white Helix reinforcement
MHDC012	3/4" I.D. Clear Vinyl with white Helix reinforcement
MHDC014	7/8" I.D. Clear Vinyl with white Helix reinforcement
MHDC016	1" I.D. Clear Vinyl with white Helix reinforcement
MHDC018	1-1/8" I.D. Clear Vinyl with white Helix reinforcement
MHDC020	1-1/4" I.D. Clear Vinyl with white Helix reinforcement
MHDC022	1-3/8" I.D. Clear Vinyl with white Helix reinforcement
MHDC024	1-1/2" I.D. Clear Vinyl with white Helix reinforcement
MHDC026	1-5/8" I.D. Clear Vinyl with white Helix reinforcement
MHDC032	2" I.D. Clear Vinyl with white Helix reinforcement

Heavy duty abrasion cover sleeves



Accessories

#	Description
508-J-500-10	MHDC010, MHDC011
510-A-500-12	MHDC012
612-400-14	MHDC014
216-200-18	MHDC016, MHDC018
620-100-18	MHDC018 (w/2640N-08 hose)
220-200-22	MHDC022, MHDC024
520-A-500-26	MHDC026

Spring guards



#	Description
MSG060	0.60" I.D. Continuous Spring
MSG2006	For 2245N-04V00 Hose
MSG2106	For 2380N-04V00 Hose
MSG4113	For -8 Hoses
MSG4120	For 2440n-12V37 Hose
MSG4125	For 2440N-16V37 Hose

Support grips

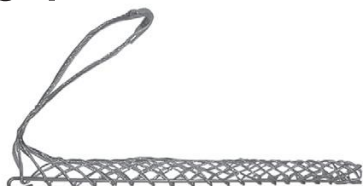

#	Description
MK022-03-038	For Hose O.D. 0.63" - 0.74"
MK022-03-039	For Hose O.D. 0.75" - 0.99"
MK022-03-041	For Hose O.D. 1.00" - 1.24"
MK022-03-042	For Hose O.D. 1.25" - 1.49"
MK022-03-043	For Hose O.D. 1.50" - 1.74"
MK022-03-045	For Hose O.D. 2.25" - 2.49"

PVC-S - Anti-abrasion sleeve

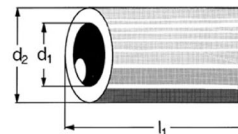

COLOUR Yellow

NOTE As an alternative, rubber anti-abrasion sleeves are available

#		For hose				Diameter in mm		Hose type	Mountable Length in m
Protective sleeve	Clamp ferrule	DN	size	mm	inch	d1	d2		l1
PVC-S-03	KL-03	5	-03	4.8	3/16	22	28	2640D-03	20/40
PVC-S-05	KL-05	8	-05	7.9	5/16	27	33	2640D-05	20/40
PVC-S-08	KL-08	12	-08	12.7	1/2	35	45	2640N-08	20
PVC-S-12	KL-12	20	-12	19.0	3/4	40	50	2640N-12	20
PVC-S-16	KL2543	25	-16	25.4	1	55	65	2640N-16	20

HS - Containment grips

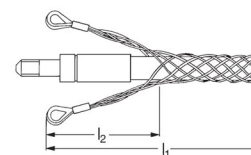

MATERIAL electrogalvanized steel wire

NOTE *F-KN 3/9: working load 3 KN, breaking load 9 KN, e.g. DN5

#	For hose						Total Length	Length of Loops in mm
Protective sleeve	DN	size	mm	inch	Ø mm	F-KN*	l1	l2
HS-03	5	-03	4.8	3/16	9-15	3/9	600	200
HS-05	8	-05	7.9	5/16	15-20	6/18	600	200
HS-08	12	-08	12.7	1/2	20-30	11/33	600	200
HS-12	20	-12	19.0	3/4	30-40	11/33	600	200
HS-16	25	-16	25.4	1	40-50	16/48	600	200

UHPLABEL – Precautions for ultra-high pressure applications



MATERIAL self-adhesive PE sticker

#	Dimensions
UHPLABEL	60 x 250 mm

Chapter F**Technical information**

Installation tips	F-2
Selection, installation, and maintenance of polyflex hose and hose assemblies	F-3
Dash sizes	F-4
Selection of hose diameter from flow rate and velocity	F-5
Pressure drop	F-6
Glossary	F-11
Permeability coefficient	F-12
Recommended tightening procedures	F-13
Metric conversion chart	F-14
General chemical resistance table	F-15
Parker Safety Guide	F-20
Technical Overview Hose by Inside Diameter	F-24

Installation tips

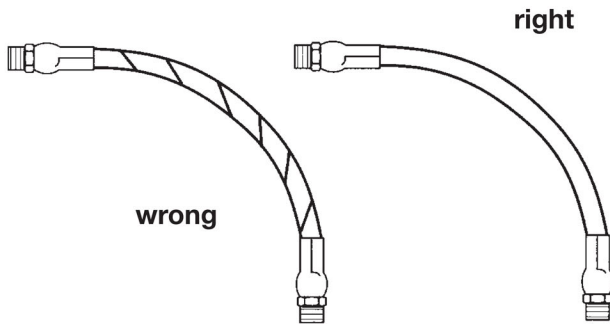

Hose is weakened when installed in twisted position. Also, pressure pulses in twisted hose tend to fatigue wire and loosen fitting connections. Design so that machine motion produces bending rather than torsion.

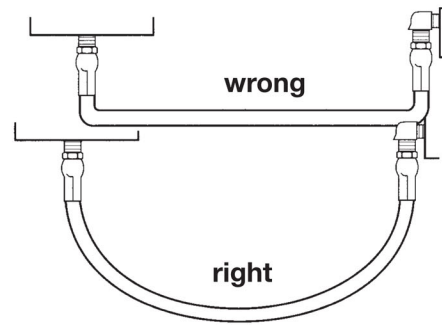

Hose should exit coupling in a straight position rather than side loaded. The minimum bend radius must not be exceeded to avoid kinking of hose and flow restriction.

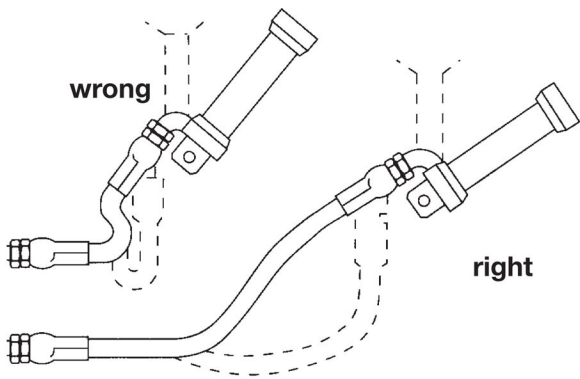

When hose assembly is installed in a flexing application, remember that metal hose fittings are not part of the flexible portion.

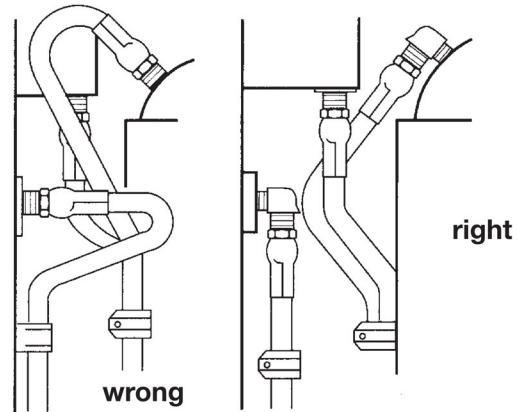

Use elbows or adaptors as necessary to eliminate excess hose length and to ensure neater installation and easier maintenance.

Free hose length allowance:

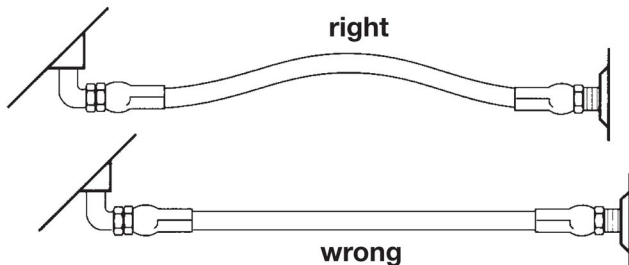

Pressure can change hose in length by as much as $\pm 2\%$. This must be considered when cutting hose to appropriate length.

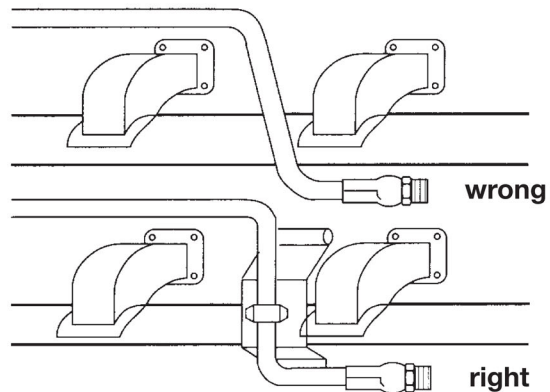

Avoid installing hose assemblies close to heat sources. However, if this should be required, insulate hose.

Selection, installation, and maintenance of Polyflex hose and hose assemblies

Hose and hose assemblies have a finite life span and many factors can reduce this time. This recommended practice should be read by designers and users of hose to assist them in the proper selection of hose. These guidelines, while not exhaustive, will assist the user in maintaining hydraulic and pneumatic systems.

READ THE PARKER SAFETY GUIDE CONTAINED IN THIS CATALOGUE IN ITS ENTIRETY.

PART 1 - How to select hose

- **Pressure** - Maximum operating pressure of the hose must be greater than or equal to the system pressure. Pressure surges or system “spikes” in excess of the maximum operating pressure will shorten hose life and must be avoided.
- **Temperature** - Ambient and fluid temperatures must not exceed the hose/fittings rated design temperature. Attempt to route hose or shield hose from high temperature sources.
- **Size** - Adequately size hose and fittings to avoid damaging hose with excessive turbulence, or heat build-up, while maintaining proper flow and pressure. (Refer to fluid velocity nomogram.)
- **Fluid Compatibility** - Refer to Chemical Compatibility Guide in this catalog for use of fluids with various materials. If unsure of an application, contact the factory. Additional care must be taken with gaseous applications.
- **Environment**- Conditions such as ozone, UV light, harsh chemicals, salt water, and other airborne contaminants can degrade hose and shorten its life.
- **Length** - Hose length changes with pressure. This, along with equipment movement, must be considered in the system design.
- **Proper couplings** - Always follow manufacturers specifications and do not mix components of different manufacturers.
- **Mechanical loads** - Conditions such as tensile and side loads, vibration, excessive flexing, and twist will reduce hose life. Use swivel fittings and adaptors to avoid hose twisting. Test the hose if the application is potentially problematic or unusual.
- **Electrical conductivity** - Determine if the hose must be non-conductive to prevent electrical current flow or conductive to dissipate static electricity. Choose hose and fittings accordingly.

PART 2 - Installation and maintenance

- **Inspect components** - Check hose for cover cracks, blisters, cleanliness, kinks, cracks or core tube obstructions or other defects. Examine fittings for poor threads, obstructions, cracks, rust. Do not use hose or fittings if these problems exist.
- **Assemble per instructions** - Instructions are available for companies, trained and authorized by Polyflex.
- **Do not exceed specified minimum bend radius** - Use stress relievers to prevent sharp bends at the hose and fitting juncture. These can be spring guards or other stress relieving members.
- **Ensure that hose bends rather than twists with equipment motion.**
- **Use a torque wrench or the flats from finger tight method to properly install port connections.**
- **After installation, eliminate air entrapped in system, pressurise to maximum operating pressure, and check for leaks and proper system function.**
- **After installation, periodically (frequency depends on severity of application and potential risk) inspect the system for the following:**
 1. Blistered, degraded, or loose hose covers.
 2. Stiff, cracked, or charred hose.
 3. Cuts or abrasion of hose. Look for exposed reinforcement.
 4. Leaks in hose or fittings.
 5. Damaged or corroded fittings.
 6. Excessive build up of dirt, grease, oils, etc.
 7. Defective or broken accessories (clamping devices, kink guards)
 8. Kinks in hoses.

Upon discovery of any of these items, replace it, repair it, but **DO NOT IGNORE IT!**

- Retest the system after all maintenance procedures.
- Establish replacement schedules based on previous service life, or when failures could result in damage, personal injury, excessive or unacceptable downtime.

Dash sizes

Dash sizes

Dash sizes are commonly used to designate hose I. D., plastic tubing and metal tubing O. D. and coupling size. Dash size systems in common use:

Nominal hose I.D. or tubing O.D.		Dash number for all polyflex hose	Nominal DN size
Inches	Millimeters		
3/32	2.0	-012	2
1/8	3.2	-2	3
5/32	4.0	-025 or 2A	4
3/16	4.8	-3	5
1/4	6.3	-4	6
5/16	7.9	-5	8
3/8	9.5	-6	10
13/32	10.3	-6.5	-
1/2	12.7	-8	12
5/8	15.9	-10	16
3/4	19.1	-12	20
7/8	22.2	-14	-
1	25.4	-16	25
1-1/8	28.6	-	-
1-1/4	31.8	-20	32
1-3/8	34.9	-	-
1-1/2	38.1	-24	40
1-13/16	46.0	-	-
2	50.8	-32	50

Selection of hose diameter from flow rate and velocity

Flow capacities of Parker hose at recommended flow velocities

The chart below is provided as an aid in the determination of the correct hose size. Suitable for hydraulic applications.

Example:

at 10 gallons per minute (gal/min), what is the proper hose size within the recommended velocity range for pressure lines?

Locate 10 gallons per minute in the left-hand column and 25 feet per second in the right-hand column (the maximum recommended velocity range for pressure lines). Lay a straight line across these two points. The inside diameter shown in the centre column is above -6 so we have to use -8 (1/2").

For suction hose, follow the same procedure except use recommended velocity range for intake lines in the right-hand column.

where: Q = flow in gallons per minute (gal/min & l/min)
 V = velocity in feet per second (f/s & m/s)
 d = hose inside diameter (mm & dash size)

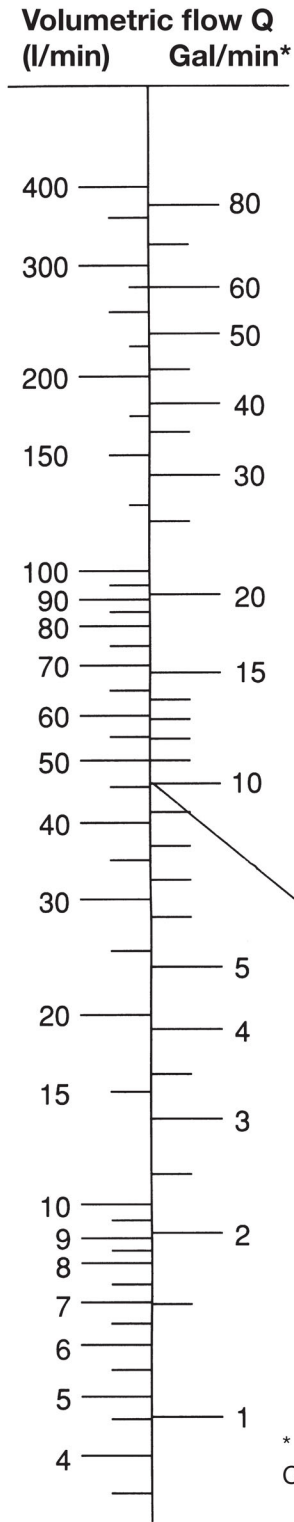

Hose inner diameter d	
mm	dash sizes
50,8	-32
38,1	-24
31,8	-20
25,4	-16
19,1	-12
15,9	-10
12,7	-8
9,5	-6
7,9	-5
6,3	-4
4,8	-3

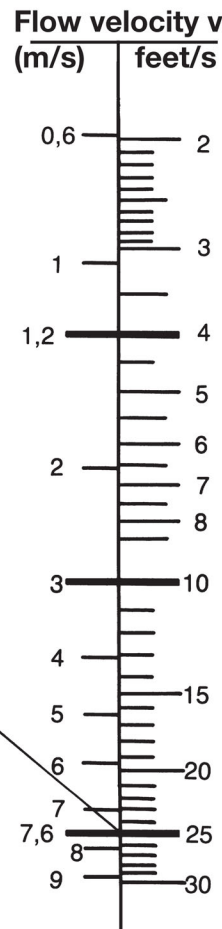

Recommended maximum velocity for suction lines

Recommended maximum velocity for return lines

Recommended maximum velocity for pressure lines

* gallons are UK gallons
 Conversion factors: gal/min x 4.546 = l/min
 feet/s x 0.3948 = m/s

* Recommended velocities are according to hydraulic fluids of maximum viscosity 315 S.S.U. at 38 °C working at roomtemperature within 18 ° and 68 °C.

Pressure drop

For size -02 (3 mm) hoses

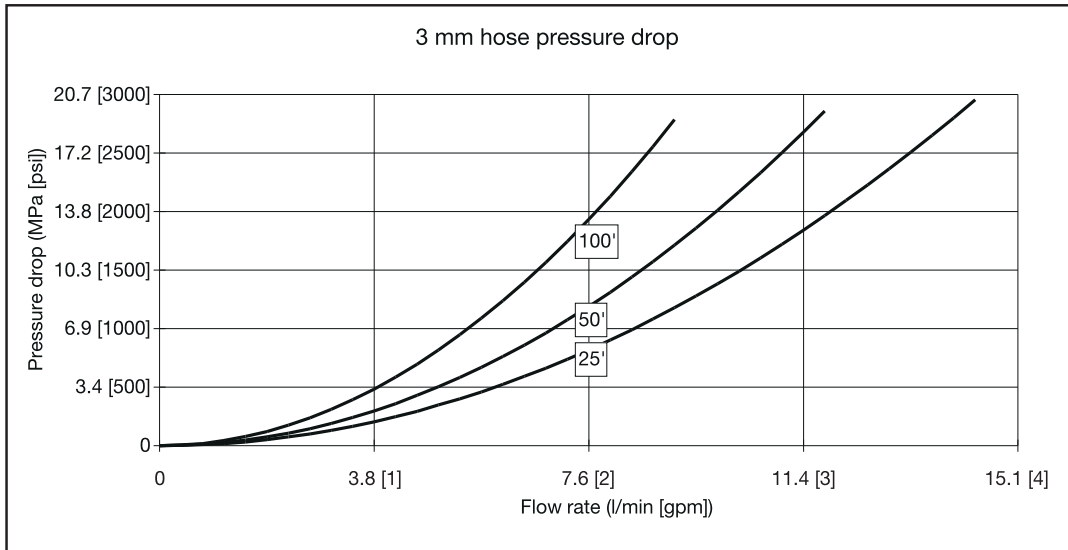

For size -025 (4 mm) hoses

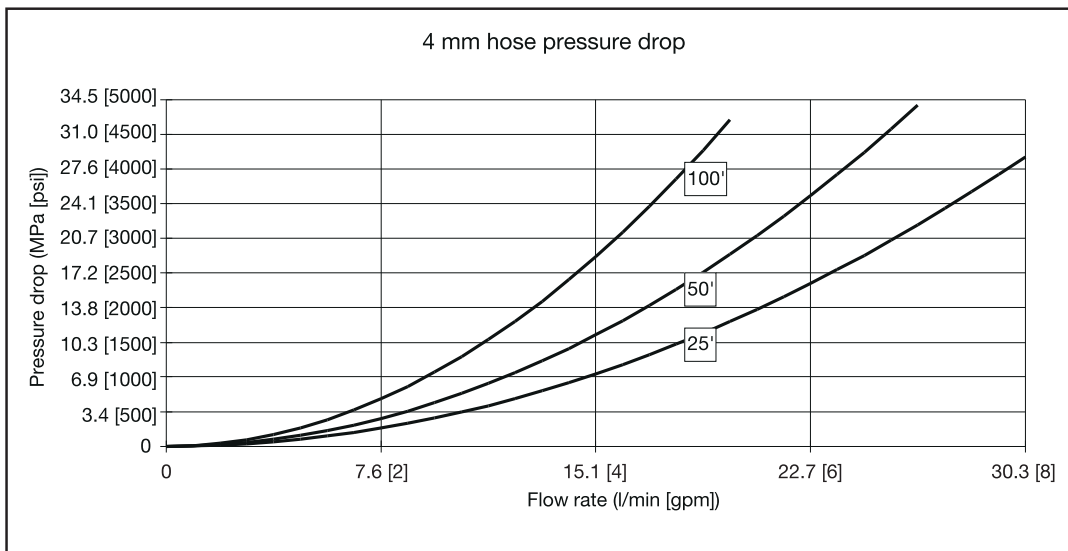

- Results obtained from actual pressure drop tests, pumping water through hose assemblies with normal end fittings.
- The lines in the graphs represent examples of hose assembly lengths, e.g. 100' = 100 feet

For size -03 (5 mm) hoses

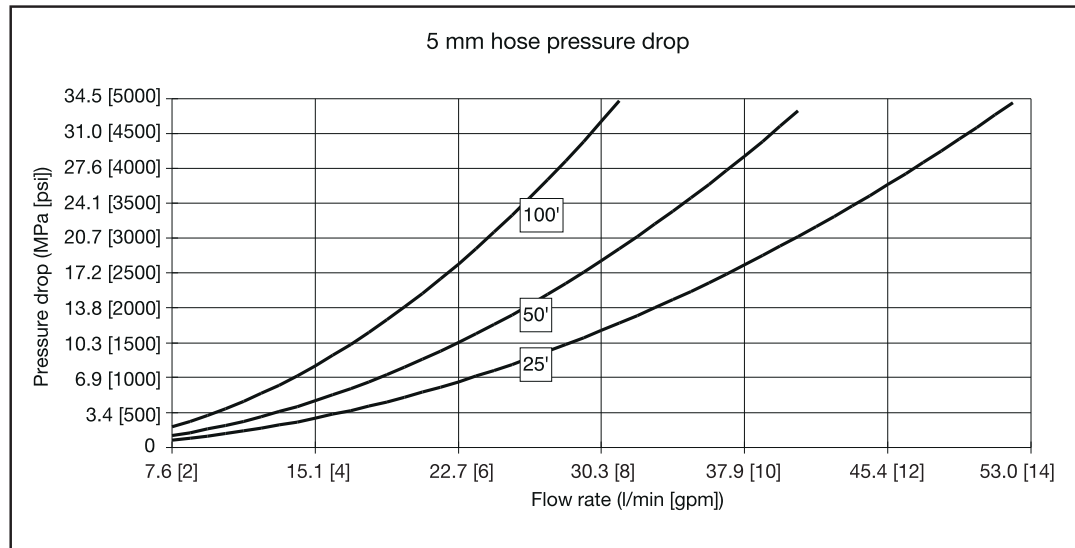

- Results obtained from actual pressure drop tests, pumping water through hose assemblies with normal end fittings.
- The lines in the graphs represent examples of hose assembly lengths, e.g. 100' = 100 feet

For size -04 (6 mm) hoses

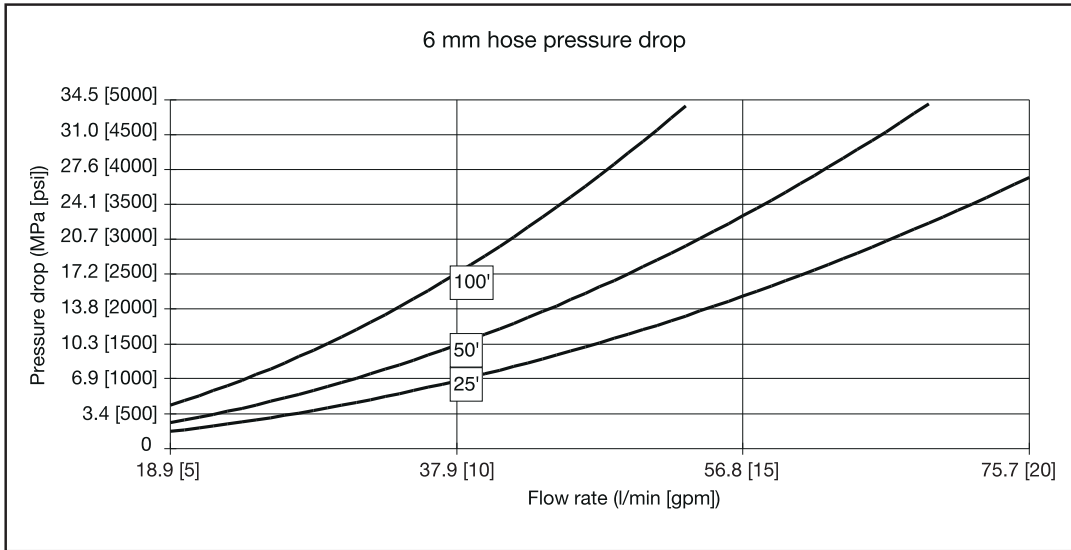

For size -05 (8 mm) hoses

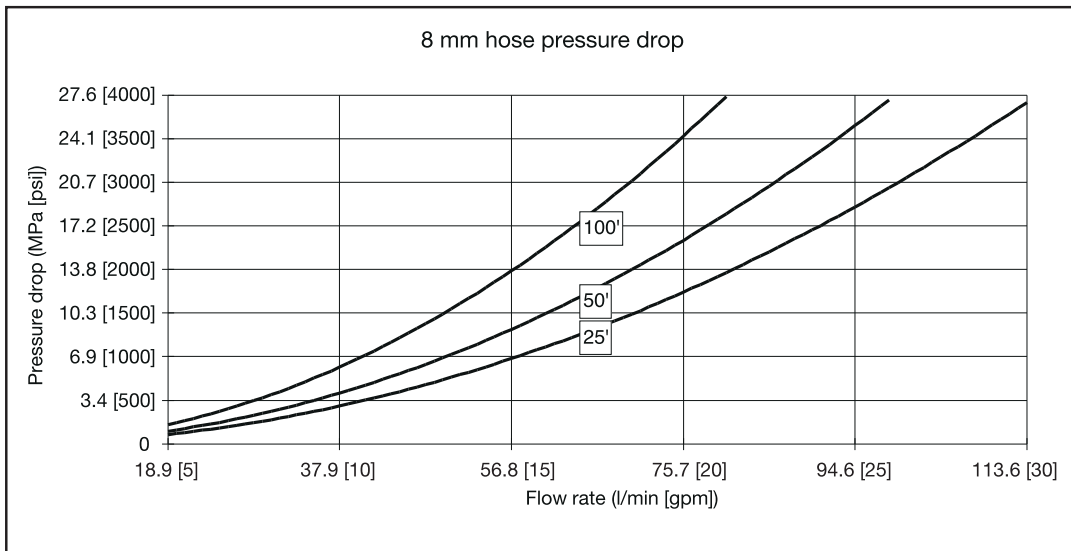

- Results obtained from actual pressure drop tests, pumping water through hose assemblies with normal end fittings.
- The lines in the graphs represent examples of hose assembly lengths, e.g. 100' = 100 feet

For size -06 (10 mm) hoses

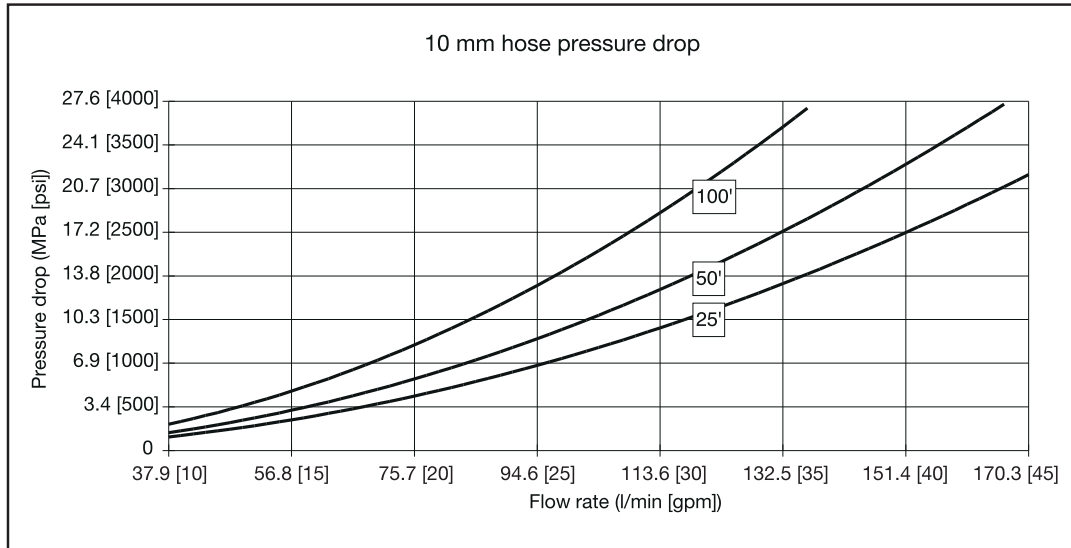

For size -08 (13 mm) hoses

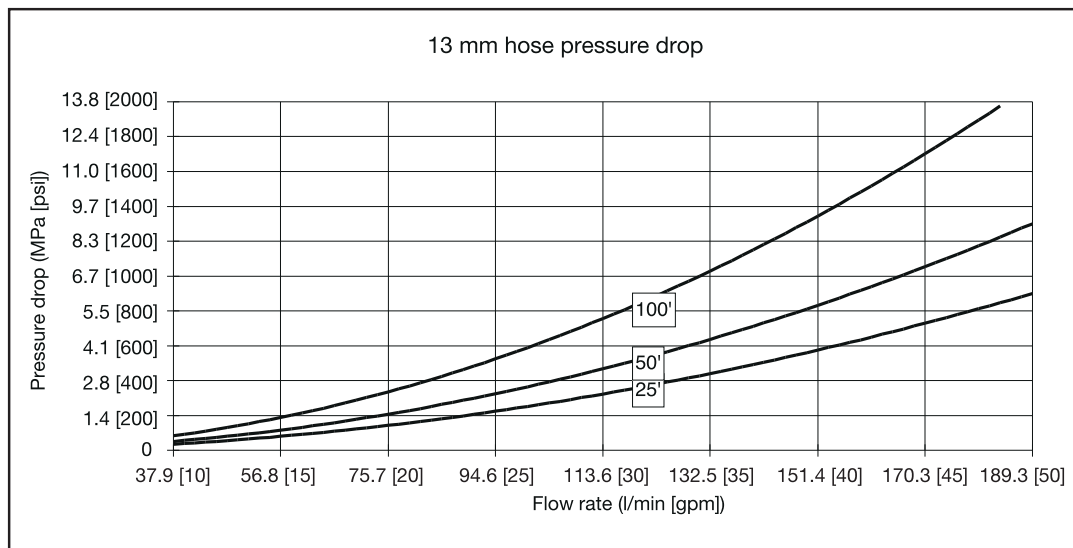

- Results obtained from actual pressure drop tests, pumping water through hose assemblies with normal end fittings.
- The lines in the graphs represent examples of hose assembly lengths, e.g. 100' = 100 feet

For size -12 (20 mm) hoses

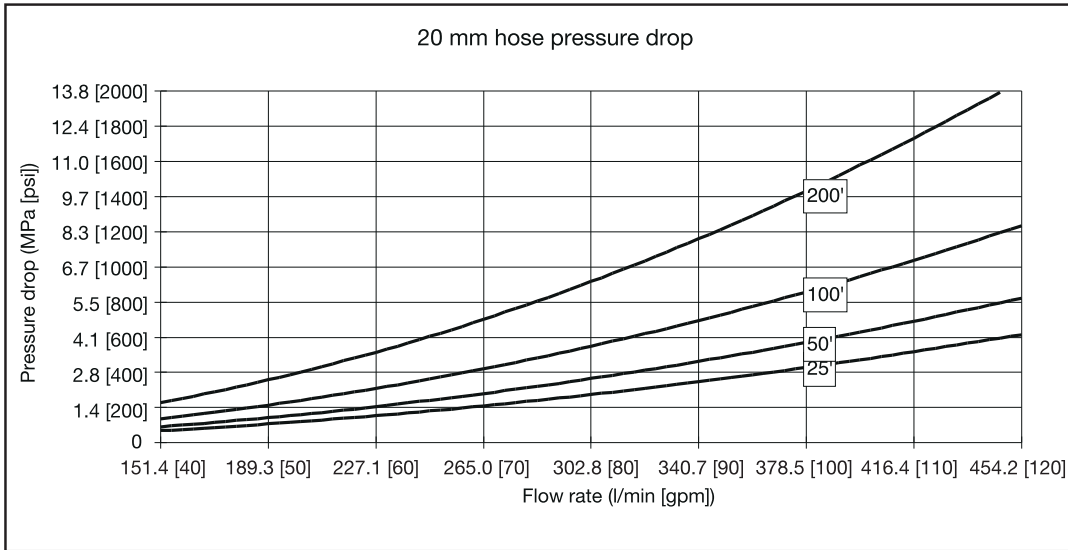

For size -16 (25 mm) hoses

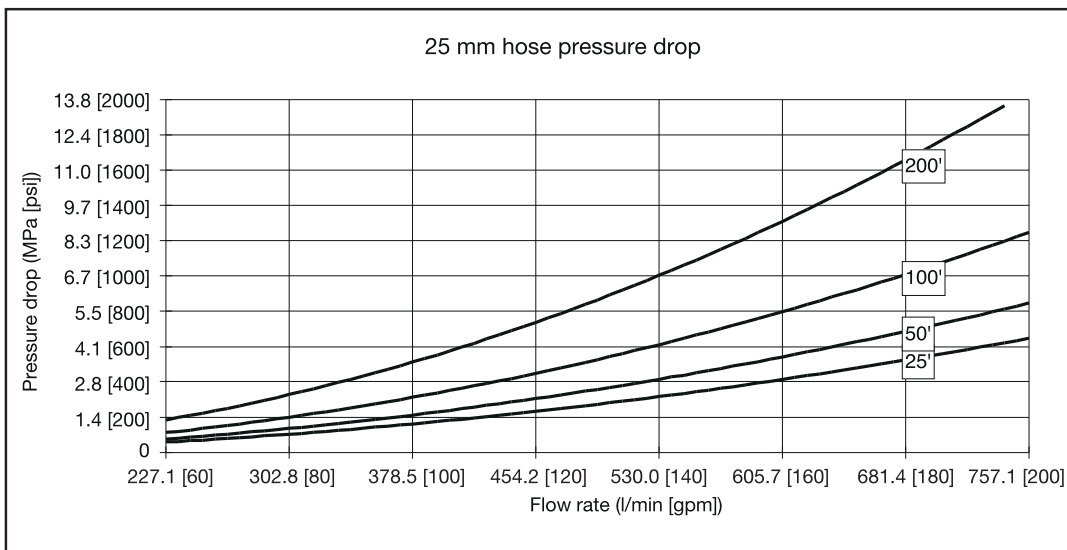

- Results obtained from actual pressure drop tests, pumping water through hose assemblies with normal end fittings.
- The lines in the graphs represent examples of hose assembly lengths, e.g. 100' = 100 feet

Glossary

Abrasion

Abrasion occurs in numerous forms; two of the more common are the typical rubbing or chafing, with the second being very high frequency, low amplitude friction. This type of abrasion results from pump pressure pulses otherwise known as pump ripple. It can also be caused by equipment vibration or resonance. Abrasion may occur when two hose lines cross or when a hose line rubs or bears against a fixed point. Abrasion resistance is also a function of temperature and attack of the cover material by aggressive chemicals.

Spring guards or other protective sleeving can also ward off premature hose failure resulting from abrasion. Spring guards also distribute bending force often associated with excessive side loading or even kinking at the skirt of the coupling.

Ambient temperature

Exceedingly high or low ambient temperatures will affect the materials from which the hose is constructed and will negatively influence hose life. When at all possible, the hose should be routed in such a manner as to protect it from heat sources. In extreme cold applications, the equipment should be designed with remote relief valves to allow circulation and warming of the oil before hose articulation is attempted. The hose liner (core tube) of choice for extremely high or low temperature is Teflon®. Teflon® is serviceable at temperatures as low as -100°F and as high as +450°. Consult the specific hose operating parameters for more information.

Bend radius

The minimum bend radii listed in this catalog are valid at rated working pressures and indicated service temperatures. Service life of a hose may be shortened if the minimum radius is exceeded or if the hose is flexed continuously in use.

Burst pressure and working pressure

The specified burst pressure for each hose style and dash size are for unaged hoses tested at normal laboratory temperature in accordance with SAE J343 specification for normal service and technically ideal installations. The maximum recommended working pressure is 1/4 of the mini-

mum rated burst pressure, except as otherwise specifically stated in those product specifications. For more severe service, a higher rated working pressure hose may have to be selected.

Hose installation tips

Establish hose size (I. D.) and style based upon flow rate (GPM), pressure drop, and chemical compatibility with fluid medium. Other significant factors to be considered in hose selection and installation are discussed briefly as follows:

Operating temperature

The temperature range for satisfactory service (maximum hose life) depends to a great extent upon the fluid being conveyed. Use of a hose above maximum specified temperature ratings will shorten hose life due, but not limited, to oxidation, chemical degradation and loss of compression within the coupling.

Pressure effects

Pressure surges and system shocks (spikes) are common in hydraulic systems. The normal 4:1 design factor should reflect these transient pressures. Where these surges and shocks are considered severe or hazardous, the design factor should be increased.

When hose is under pressure, it may change in length by as much as $\pm 3\%$. Installation should compensate for shortening by providing an appropriate amount of slack and for lengthening by allowing space for this growth to be absorbed.

Routing and clamping

Whenever possible, and maximum efforts should be made to do so, hose should be routed to flex in a single plane. Routing hoses in flexure through compound bends results in torsions. When this is unavoidable, the torsion should be distributed over the maximum hose length possible. Wire reinforced hoses suffer the most rapid and severe loss of service life when applied in torsion. Extremely tight and improperly located clamps focus this torsion over short distances.

Analysis of the hose function is required before

the proper clamping techniques can be selected. In some applications, hoses must be contained to stay out of harm's way and at the same time be free to come and go with equipment articulation. Other applications may require restrictive clamping, in which case a protective material should be used around the hose to provide the grasp without deformation of the hose by the clamp. These techniques also apply to the use of the popular method of clamping and clustering hoses with plastic tie straps.

Parker swivel adaptors feature 360° swiveling action that especially suits them for use in applications where hose moves, bends or twists. Swivel adapters connected to hose assemblies relieve twisting, prevent excessive flexing of hose, eliminate need for long radius bends, and cushion intraline shock caused by peak system pressure pulses.

High pressure adapters

It is critical that the adapter material be properly suited to the fluid media. Widely varying conditions frequently necessitate high pressure adapters constructed of materials other than conventional 316 stainless steel. Since many variables affect the corrosion resistance of metallic materials, it is Parker Hannifin's policy not to recommend materials based on corrosion resistance for specific fluid applications. The published recommended working pressure represent the capability of the subject fitting. Nevertheless, in some instances, the hose, hose fitting or other connector assembled to the adapter may dictate the maximum working pressure. The end-user should read and understand the Parker Safety Guide (Bulletin 4400-B.1) and follow its suggested practices and warnings.

Permeability coefficient

$$\text{Permeability Coefficient} = \frac{V}{A \times T \times p}$$

Where: V is the volume of gas, in cm³, which diffuses through a 1mm thickness.

A is the area across which the gas diffuses, in m².

T is the diffusion time, in days.

p is the pressure difference across the plastic, in bar.

Permeability Coefficients per DIN 53380

Material	Gas				
	N ₂	O ₂	CO ₂	H ₂	He
PTFE	50	150	1500	—	3500
PVDF	3	2	10	—	60
PA-6 XE 3289	1	4	10	100*	60*
PA-6 A 28 NZ	0.5	2	5	50*	30*
PA-12 L 2124	—	30	180	210	160
PA-12 P40 TL	—	—	105	—	—
PA-12 L 25W40	8	35	150	1000*	500*
PA-12 L 2140	—	12	71	—	130
PA-11 P 40 TL	—	—	55	130	—
PA-11 POTL	2	20	65	65	—
POM H 2320	5	10	130	35	40
POM 150 SA	2	4	20	—	—
PEE 4055	150	—	3000	—	1400
PEE 5556	120	—	1600	—	900
PEE 7246	—	—	—	—	300

* Calculated value. Diffusion constants based on normal room temperature. Actual behavior may vary considerably because of variations in processing the plastic.

Recommended tightening procedures

Connection	Thread sizes	Tightening torque	
		ft•lb	N•m
High Pressure			
1/4"	9/16" - 18	25	34
3/8"	3/4" - 16	50	69
9/16"	1-1/8" - 12	75	103
Medium Pressure			
1/4"	7/16" - 20	20	28
3/8"	9/16" - 18	30	41
9/16"	13/16" - 16	85	117
3/4"	3/4" NPSM	90	124
1"	1-3/8" - 12	125	173
Type "M" Swivel			
A9	9/16" - 18	25-30	34-41
A12	3/4" - 16	40-50	55-69
A14	7/8" - 14	50-60	69-83
A16	1" - 12	75-85	103-117
A21	1-5/16" - 12	100-120	138-166

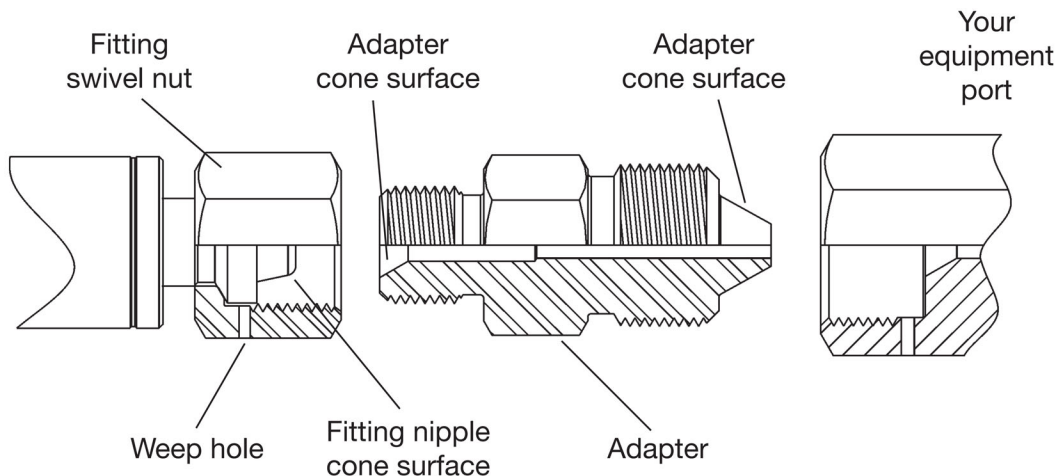

Leakage at swivel nut-to-adapter Joint
 (Seen by leak at weep hole in swivel nut)

1. Reduce system pressure to zero
2. Unscrew swivel nut and check cone surfaces of adapter and hose insert.
3. If hose insert is damaged, return hose to **polyflex** for repair and retest.
4. If cone surfaces look good after cleaning, re-tighten swivel nut. Do not exceed 150% of recommended torque.

Leakage at type "M" adapter-to-port
 (Seen by leak at weep hole in pressure port, or leak at threads for NPT adapters.)

1. Reduce system pressure to zero.
2. Slacken hose swivel nut.
3. Tighten adaptor into port.
4. Re-tighten swivel nut.

Never use the swivel nut to tighten the adapter into the port.

Metric conversion chart

	English to Metric			Metric to English		
	To Convert From	To	Multiply	To Convert From	To	Multiply
Area	sq. in. (in ²)	sq. mm (mm ²)	645.16	sq. mm (mm ²)	sq. in. (in ²)	0.00155
	sq. in. (in ²)	sq. cm (cm ²)	6.4516			
	sq. ft. (ft ²)	sq. meters (m ²)	0.0929			
Density	pounds/cubic foot (lb/ft ³)	Kilograms/cubic meter (kg/m ³)	16.02	Kilograms/cubic meter (kg/m ³)	pounds/cubic foot (lb/ft ³)	0.0624
Energy	British Thermal Units (Btu) (1 J = Ws = 0.2388 cal)	joules (J)	1055	joules (J)	British Thermal Units (Btu)	0.000947
Force	pounds - force (lbf) (1N = 0.102 kgf)	newtons (N)	4.448	newtons (N)	pounds - force (lbf)	0.2248
Length	inches (in)	millimeters (mm)	25.4	millimeters (mm)	inches (in)	0.03937
	feet (ft)	meters (m)	0.3048	meters (m)	feet (ft)	3.281
	miles (mi)	kilometers (km)	1.609	kilometers (km)	miles (mi)	0.621
Mass (Weight)	ounces (oz.)	grams (g)	28.35	grams (g)	ounces (oz.)	0.035
	pounds - mass (lb)	kilograms (kg)	0.4536	kilograms (kg)	pounds - mass (lb)	2.205
	short tons (2000 lb) (tn)	metric tons (1000 kg)	0.9072	metric tons (1000 kg)	short tons (2000 lb) (tn)	1.102
Power	horsepower (550 ft. lb/s) (hp)	kilowatts (kW)	0.7457	kilowatts (kW)	horsepower (550 ft. lb/s) (hp)	1.341
Pressure	pounds/square inch (psi)	kilograms (f)/square cm (kg(f)/cm ²)	0.0703	kilograms (f)/square cm (kg(f)/cm ²)	pounds/square inch (psi)	14.22
	pounds/square inch (psi)	kilopascals (kPa)	6.8948	kilopascals (kPa)	pounds/square inch (psi)	0.145
	pounds/square inch (psi)	bars (100 kPa)	0.06895	bars (100 kPa)	pounds/square inch (psi)	14.503
Stress	pounds/square inch (psi) (1N/mm ² = 1MPa)	megapascals (MPa)	0.006895	megapascals (MPa)	pounds/square inch (psi)	145.039
Temperature	degrees Fahrenheit (°F)	degrees Celsius (°C)	5/9 (after subtracting 32)	degrees Celsius (°C)	degrees Fahrenheit (°F)	9/5 (then add 32)
Torque or Bending Moment	pounds-force-foot (lb-ft)	Newtons-meter (Nm)	1.3567	Newtons-meter (Nm)	pounds-force-foot (lb-ft)	0.737
	pounds-force-inch (lb-in)	Newtons-meter (Nm)	0.113	Newtons-meter (Nm)	pounds-force-inch (lb-in)	8.85
Velocity	feet/seconds (ft/s)	meters/second (m/S)	0.3048	meters/second (m/S)	feet/seconds (ft/s)	3.2808
Viscosity	dynamic (centipoise)	Pascal-second (Pas)	0.001	Pascal-second (Pas)	dynamic (centipoise)	1000
	kenematic-foof/sec (ft ² /s)	meter ² /sec (m ² /s)	0.0929	meter ² /sec (m ² /s)	kenematic-foof/sec (ft ² /s)	10.7643
Volume	cubic inch (in ³)	cubic centimeter (cm ³) (milliliter)	16.3871	cubic centimeter (cm ³) (milliliter)	cubic inch (in ³)	0.061
	quarts (qt)	liters (1000 cm ³)	0.9464	liters (1000 cm ³)	quarts (qt)	1.057
	gallons (gal)	liters	3.7854	liters	gallons (gal)	0.2642

General chemical resistance table

Ratings code

- G – Good to excellent. Little or no swelling, tensile or surface changes. Preferred choice.
- L – Marginal or conditional. Noticeable effects but not necessarily indicating lack of serviceability. Further testing suggested for specific application. Very long-term effects such as stiffening or potential for crazing should be evaluated.
- P – Poor or unsatisfactory. Not recommended without extensive and realistic testing.
- – Indicates that this was not tested.

Materials code for hose core tubes

- N** Polyamide
- M** Coextruded tube with Fluoropolymer inner liner

Materials code for hose cover

- N** Polyamide
- U/HF** Polyurethane

Notes on the chemical resistance table

- (1) The fluid resistance tables are simplified rating tabulations based on immersion tests at 24° C. Higher temperatures tend to reduce ratings. Since final selection depends on pressure, fluid and ambient temperature and other factors not known to Parker Hannifin, no performance guarantee is expressed or implied. The indications do not imply any compliance with standards and regulations and do not refer to possible changes of colour, taste or smell. For food and drinking water specially approved materials have to be used. For fluids not listed or for advice on particular applications, please consult Parker Hannifin GmbH, **polyflex** Division in Hüttenfeld, Germany.
- (2) Hose applications for these fluids must take into account legal and insurance regulations. The chemical resistance indicated does not express or imply approval by certain institutions.
- (3) Satisfactory at some concentrations and temperatures, unsatisfactory at others.
- (4) For gas applications, the cover should be pin-pricked and the pressure must not be released quickly. Special safety guard accessories are to be used to prevent damage or personal injury in the event of failure..
- (5) Chemical resistance does not imply low permeation rates. Please consult Parker Hannifin for a recommendation for your specific requirements.
- (6) The indication of chemical resistance does not imply any special food compatibility; it refers only to the chemical resistance of the material.
- (7) Chemical resistance does not imply acceptability for use in airless paintspray applications. These applications require a special, electrically conductive hose.

Not all remarks may apply to Oil&Gas products

Chemical	N	U/HF	M
Acetone	G	P	L
Acetylene	--	--	--
Air (4)	G	G	G
Ammonium Chloride	P	G	G
Ammonium Hydroxyde	G	P	G
Anhydrous Ammonia	P	P	--
Aniline	P	P	G
Aromatic Hydrocarbons	G	L	--
Asphalt	G	G	L
Benzene	G	L	G
Butane (2) (4)	G	L	--
Calcium Chloride	--	G	G
Carbon Dioxide (4)	G	G	--
Carbon Monoxide (4)	--	G	--
Carbon Tetrachloride	G	P	G
Chlorinated Hydrocarbon Base Fluids	G	L	--
Chlorinated Petroleum Oil	G	L	--
Chlorinated Solvents	--	P	--
Chlorine, Gaseous, Dry	P	P	--
Chromic Acid	--	P	L
Citric Acid Solutions	G	L	G
Crude Petroleum Oil	G	G	--
Cyclohexan (2)	G	G	G
Diesel Fuel (2)	G	G	--
Diester Oils	G	P	--
Ethanol (6)	G	L	--
Ethers	G	P	G
Ethylene Glycol	G	L	G
Ethylene Oxide	G	L	--
Fatty Acids	G	--	G
Formaldehyde	L	P	G
Formic Acid J	P	P	G
Fuel Oil (2)	G	L	G
Gas (Oil) (2)	G	G	
Gasoline	G	--	G
Glycerine	G	L	G

General chemical resistance table

Chemical	N	U/HF	M
Glycols (to 135 °F)	G	L	G
Grease (petroleum base)	G	G	--
Hexane (2)	G	G	G
Hydraulic Fluid (petroleum base)	G	G	L
Hydraulic Fluid phosphate ester base)	G	L	--
Hydraulic Fluid water base)	G	G	--
Hydraulic oil (petroleum base)	G	G	L
Hydrochloric Acid	L	P	G
Hydrofluoric Acid	P	P	G
Hydrolube (hydraulic fluid/water glycol base)	G	L	--
IRUS 902 (hydraulic fluid/water-oil emulsion)	G	G	--
Isooctane (2)	G	G	G
Kerosene (2)	G	L	G
Ketones	G	P	G
Lime (calcium oxide)	G	G	G
Lindol (hydraulic fluid/phosphate esters)	G	P	--
LP-Gas	--	--	--
Lubricating Oils (diester base)	G	P	--
Lubricating Oils (petroleum base)	G	G	G
Methane	--	--	--
Methanol	G	P	--
Methyl Alcohol (6)	G	P	G
Methyl Ethyl Ketone (MEK)	G	P	G
Methyl Ethyl Ketone Peroxide (MEKP)	L	P	--
Methyl Isobutyl Ketone (MIBK)	G	P	G
Methylen Chloride	L	P	G
Mineral Oil	G	G	G
Mineral Spirits	--	L	--
Motor Oils	G	G	G
Naphta	G	P	G
Natural Gas (4)	--	--	--
Nitric Acid	P	P	L
Nitrobenzene	G	P	G
Nitrogen, Gaseous (4) (5)	G	G	G
Nitrous Oxide	L	--	--
Oil (SAE)	G	G	--

Chemical	N	U/HF	M
Oxygen, Gaseous (4) (5) (6)	G	G	G
Pentane (2)	G	L	G
Perchloric Acid	P	P	L
Petroleum Ether	--	--	--
Petroleum Oils	G	G	--
Phenols	P	P	--
Phosphate Esters (above 135 °F)	G	P	--
Phosphate Esters (to 135 °F)	G	P	--
Propane (4) (5)	--	--	--
Propylen Glycol	--	G	G
Salt Water	--	--	G
Silicone Greases	G	G	--
Silicone Oils	G	G	--
Sodium Borate	G	G	G
Sodium Carbonate	--	--	--
Sodium Chloride Solutions	G	G	G
Sodium Hydroxide, 50%	P	P	G
Sodium Hypochloride	P	P	G
Steam	P	P	G
Straight Synthetic Oils (phosphate esters)	G	P	--
Sulphur Dioxide	L	L	G
Sulphur Hexafluoride Gas (4) (5)	G	G	--
Sulphuric Acid	P	P	--
Toluol, Toluene	G	L	G
Trichlorethylene	L	P	G
Ucon (hydraulic fluid/water glycol base)	G	L	--
Water (above 60 °C) (6)	G	P	L
Water (to 60 °C) (6)	G	G	G
Water Glycols (above 60 °C)	L	P	--
Water Glycols (to 60 °C)	G	L	--
Water in oil Emulsions (above 60 °C)	L	P	--
Water in oil Emulsions (to 60 °C)	G	L	--
Xylene	G	P	G
Zinc Chloride	G	G	G

Parker Safety Guide for Selecting and Using Hose, Tubing, Fittings and Related Accessories Parker Publication No. 4400-B.1 / Revised: September, 2015



WARNING

Failure or improper selection or improper use of hose, tubing, fittings, assemblies, valves, connectors, conductors or related accessories ("Products") can cause death, personal injury and property damage. Possible consequences of failure or improper selection or improper use of these Products include but are not limited to:

- Fittings thrown off at high speed.
- High velocity fluid discharge.
- Explosion or burning of the conveyed fluid.
- Electrocutation from high voltage electric powerlines.
- Contact with suddenly moving or falling objects that are controlled by the conveyed fluid.
- Injections by high-pressure fluid discharge.
- Dangerously whipping Hose.
- Tube or pipe burst.
- Weld joint fracture.
- Contact with conveyed fluids that may be hot, cold, toxic or otherwise injurious.
- Sparking or explosion caused by static electricity buildup or other sources of electricity.
- Sparking or explosion while spraying paint or flammable liquids.
- Injuries resulting from inhalation, ingestion or exposure to fluids.

Before selecting or using any of these Products, it is important that you read and follow the instructions below. No product from any division in Fluid Connector Group is approved for in-flight aerospace applications. For hoses and fittings used in in-flight aerospace applications, please contact Parker Aerospace Group

1.0 GENERAL INSTRUCTIONS

Scope: This safety guide provides instructions for selecting and using (including assembling, installing, and maintaining) these Products. For convenience, all rubber and/or thermoplastic products commonly called "hose" or "tubing" are called "Hose" in this safety guide. Metallic tube or pipe are called "tube". All assemblies made with Hose are called "Hose Assemblies". All assemblies made with Tube are called "Tube Assemblies". All products commonly called "fittings", "couplings" or "adapters" are called "Fittings". Valves are fluid system components that control the passage of fluid. Related accessories are ancillary devices that enhance or monitor performance including crimping, flaring, flanging, presetting, bending, cutting, deburring, swaging machines, sensors, tags, lockout handles, spring guards and associated tooling. This safety guide is a supplement to and is to be used with the specific Parker publications for the specific Hose, Fittings and Related Accessories that are being considered for use. Parker publications are available at www.parker.com. SAE J1273 (www.sae.org) and ISO 17165-2 (www.ansi.org) also provide recommended practices for hydraulic Hose Assemblies, and should be followed.

1.1 Fail-Safe: Hose, Hose Assemblies, Tube, Tube Assemblies and Fittings can and do fail without warning for many reasons. Design all systems and equipment in a fail-safe mode, so that failure of the Hose, Hose Assembly, Tube, Tube Assembly or Fitting will not endanger persons or property.

1.2 Distribution: Provide a copy of this safety guide to each person responsible for selecting or using Hose, Tube and Fitting products. Do not select or use Parker Hose, Tube or Fittings without thoroughly reading and understanding this safety guide as well as the specific Parker publications for the Products.

1.3 User Responsibility: Due to the wide variety of operating conditions and applications for Hose, Tube and Fittings. Parker does not represent or warrant that any particular Hose, Tube or Fitting is suitable for any specific end use system. This safety guide does not analyze all technical parameters that must be considered in selecting a product. The user, through its own analysis and testing, is solely responsible for:

- Making the final selection of the Products.
- Assuring that the user's requirements are met and that the application presents no health or safety hazards.
- Following the safety guide for Related Accessories and being trained to operate Related Accessories.
- Providing all appropriate health and safety warnings on the equipment on which the Products are used.
- Assuring compliance with all applicable government and industry standards.

1.4 Additional Questions: Call the appropriate Parker technical service department if you have any questions or require any additional information. See the Parker publication for the Products being considered or used, or call 1-800-CPARKER, or go to www.parker.com, for

telephone numbers of the appropriate technical service department.

2.0 HOSE, TUBE AND FITTINGS SELECTION INSTRUCTIONS

2.1 Electrical Conductivity: Certain applications require that the Hose be nonconductive to prevent electrical current flow. Other applications require the Hose and the Fittings and the Hose/Fitting interface to be sufficiently conductive to drain off static electricity. Extreme care must be exercised when selecting Hose, Tube and Fittings for these or any other applications in which electrical conductivity or nonconductivity is a factor. The electrical conductivity or nonconductivity of Hose, Tube and Fittings is dependent upon many factors and may be susceptible to change. These factors include but are not limited to the various materials used to make the Hose and the Fittings, Fitting finish (some Fitting finishes are electrically conductive while others are nonconductive), manufacturing methods (including moisture control), how the Fittings contact the Hose, age and amount of deterioration or damage or other changes, moisture content of the Hose at any particular time, and other factors. The following are considerations for electrically nonconductive and conductive Hose. For other applications consult the individual catalog pages and the appropriate industry or regulatory standards for proper selection.

2.1.1 Electrically Nonconductive Hose: Certain applications require that the Hose be nonconductive to prevent electrical current flow or to maintain electrical isolation. For applications that require Hose to be electrically nonconductive, including but not limited to applications near high voltage electric lines, only special nonconductive Hose can be used. The manufacturer of the equipment in which the nonconductive Hose is to be used must be consulted to be certain that the Hose, Tube and Fittings that are selected are proper for the application. Do not use any Parker Hose or Fittings for any such application requiring nonconductive Hose, including but not limited to applications near high voltage electric lines or dense magnetic fields, unless (i) the application is expressly approved in the Parker technical publication for the product, (ii) the Hose is marked "nonconductive", and (iii) the manufacturer of the equipment on which the Hose is to be used specifically approves the particular Parker Hose, Tube and Fittings for such use.

2.1.2 Electrically Conductive Hose: Parker manufactures special Hose for certain applications that require electrically conductive Hose. Parker manufactures special Hose for conveying paint in airless paint spraying applications. This Hose is labeled "Electrically Conductive Airless Paint Spray Hose" on its layline and packaging. This Hose must be properly connected to the appropriate Parker Fittings and properly grounded in order to dissipate dangerous static charge buildup, which occurs in all airless paint spraying applications. Do not use any other Hose for airless paint spraying, even if electrically conductive. Use of any other Hose or failure to properly connect the Hose can cause a fire or an explosion resulting in death, personal injury, and property damage. All hoses that convey fuels must be grounded. Parker manufactures a special Hose for certain compressed natural gas ("CNG")

applications where static electricity buildup may occur. Parker CNG Hose assemblies comply with the requirements of ANSI/IAS NGV 4.2; CSA 12.52, "Hoses for Natural Gas Vehicles and Dispensing Systems" (www.ansi.org). This Hose is labeled "Electrically Conductive for CNG Use" on its layline and packaging. This Hose must be properly connected to the appropriate Parker Fittings and properly grounded in order to dissipate dangerous static charge buildup, which occurs in, for example, high velocity CNG dispensing or transfer. Do not use any other Hose for CNG applications where static charge buildup may occur, even if electrically conductive. Use of other Hoses in CNG applications or failure to properly connect or ground this Hose can cause a fire or an explosion resulting in death, personal injury, and property damage. Care must also be taken to protect against CNG permeation through the Hose wall. See section 2.6, Permeation, for more information. Parker CNG Hose is intended for dispenser and vehicle use within the specified temperature range. Parker CNG Hose should not be used in confined spaces or unventilated areas or areas exceeding the specified temperature range. Final assemblies must be tested for leaks. CNG Hose Assemblies should be tested on a monthly basis for conductivity per ANSI/IAS NGV 4.2; CSA 12.52. Parker manufactures special Hose for aerospace in-flight applications. Aerospace in-flight applications employing Hose to transmit fuel, lubricating fluids and hydraulic fluids require a special Hose with a conductive inner tube. This Hose for in-flight applications is available only from Parker's Stratoflex Products Division. Do not use any other Parker Hose for in-flight applications, even if electrically conductive. Use of other Hoses for in-flight applications or failure to properly connect or ground this Hose can cause a fire or an explosion resulting in death, personal injury and property damage. These Hose assemblies for in-flight applications must meet all applicable aerospace industry, aircraft engine and aircraft requirements.

2.2 Pressure: Hose, Tube and Fitting selection must be made so that the published maximum working pressure of the Hose, Tube and Fittings are equal to or greater than the maximum system pressure. The maximum working pressure of a Hose, or Tube Assembly is the lower of the respective published maximum working pressures of the Hose, Tube and the Fittings used. Surge pressures or peak transient pressures in the system must be below the published maximum working pressure for the Hose, Tube and Fitting. Surge pressures and peak pressures can usually only be determined by sensitive electrical instrumentation that measures and indicates pressures at millisecond intervals. Mechanical pressure gauges indicate only average pressures and cannot be used to determine surge pressures or peak transient pressures. Published burst pressure ratings for Hose is for manufacturing test purposes only and is no indication that the Product can be used in applications at the burst pressure or otherwise above the published maximum recommended working pressure.

2.3 Suction: Hoses used for suction applications must be selected to insure that the Hose will withstand the vacuum and pressure of the system. Improperly selected Hose may collapse in suction application.

2.4 Temperature: Be certain that fluid and ambient temperatures, both steady and transient, do not exceed the limitations of the Hose, Tube, Fitting and Seals. Temperatures below and above the recommended limit can degrade Hose, Tube, Fittings and Seals to a point where a failure may occur and release fluid. Tube and Fittings performances are normally degraded at elevated temperature. Material compatibility can also change at temperatures outside of the rated range. Properly insulate and protect the Hose Assembly when routing near hot objects (e.g. manifolds). Do not use any Hose in any application where failure of the Hose could result in the conveyed fluids (or vapors or mist from the conveyed fluids) contacting any open flame, molten metal, or other potential fire ignition source that could cause burning or explosion of the conveyed fluids or vapors.

2.5 Fluid Compatibility: Hose, and Tube Assembly selection must assure compatibility of the Hose tube, cover, reinforcement, Tube, Plating and Seals with the fluid media used. See the fluid compatibility chart in the Parker publication for the product being considered or used. This information is offered only as a guide. Actual service life can only be determined by the end user by testing under all extreme conditions and other analysis. Hose, and Tube that is chemically compatible with a particular fluid must be assembled using Fittings and adapters containing likewise compatible seals. Flange or flare processes can change Tube material properties that may not be compatible with certain requirements such as NACE

2.6 Permeation: Permeation (that is, seepage through the Hose or Seal) will occur from inside the Hose or Fitting to outside when Hose or Fitting is used with gases, liquid and gas fuels, and refrigerants (including but not limited to such materials as helium, diesel fuel, gasoline,

natural gas, or LPG). This permeation may result in high concentrations of vapors which are potentially flammable, explosive, or toxic, and in loss of fluid. Dangerous explosions, fires, and other hazards can result when using the wrong Hose for such applications. The system designer must take into account the fact that this permeation will take place and must not use Hose or Fitting if this permeation could be hazardous. The system designer must take into account all legal, government, insurance, or any other special regulations which govern the use of fuels and refrigerants. Never use a Hose or Fitting even though the fluid compatibility is acceptable without considering the potential hazardous effects that can result from permeation through the Hose or Tube Assembly. Permeation of moisture from outside the Hose or Fitting to inside the Hose or Fitting will also occur in Hose or Tube assemblies, regardless of internal pressure. If this moisture permeation would have detrimental effects (particularly, but not limited to refrigeration and air conditioning systems), incorporation of sufficient drying capacity in the system or other appropriate system safeguards should be selected and used. The sudden pressure release of highly pressurized gas could also result in Explosive Decompression failure of permeated Seals and Hoses.

2.7 Size: Transmission of power by means of pressurized fluid varies with pressure and rate of flow. The size of the components must be adequate to keep pressure losses to a minimum and avoid damage due to heat generation or excessive fluid velocity.

2.8 Routing: Attention must be given to optimum routing to minimize inherent problems (kinking or flow restriction due to Hose collapse, twisting of the Hose, proximity to hot objects or heat sources). For additional routing recommendations see SAE J1273 and ISO 17165-2. Hose Assemblies have a finite life and should be installed in a manner that allows for ease of inspection and future replacement. Hose because of its relative short life, should not be used in residential and commercial buildings inside of inaccessible walls or floors, unless specifically allowed in the product literature. Always review all product literature for proper installation and routing instructions.

2.9 Environment: Care must be taken to insure that the Hose, Tube and Fittings are either compatible with or protected from the environment (that is, surrounding conditions) to which they are exposed. Environmental conditions including but not limited to ultraviolet radiation, sunlight, heat, ozone, moisture, water, salt water, chemicals and air pollutants can cause degradation and premature failure.

2.10 Mechanical Loads: External forces can significantly reduce Hose, Tube and Fitting life or cause failure. Mechanical loads which must be considered include excessive flexing, twist, kinking, tensile or side loads, bend radius, and vibration. Use of swivel type Fittings or adapters may be required to insure no twist is put into the Hose. Use of proper Hose or Tube clamps may also be required to reduce external mechanical loads. Unusual applications may require special testing prior to Hose selection.

2.11 Physical Damage: Care must be taken to protect Hose from wear, snagging, kinking, bending smaller than minimum bend radius and cutting, any of which can cause premature Hose failure. Any Hose that has been kinked or bent to a radius smaller than the minimum bend radius, and any Hose that has been cut or is cracked or is otherwise damaged should be removed and discarded. Fittings with damages such as scratches on sealing surfaces and deformation should be replaced.

2.12 Proper End Fitting: See instructions 3.2 through 3.5. These recommendations may be substantiated by testing to industry standards such as SAE J517 for hydraulic applications, or MIL-A-5070, AS1339, or AS3517 for Hoses from Parker's Stratoflex Products Division for aerospace applications.

2.13 Length: When determining the proper Hose or Tube length of an assembly, be aware of Hose length change due to pressure, Tube length change due to thermal expansion or contraction, and Hose or Tube and machine tolerances and movement must be considered. When routing short hose assemblies, it is recommended that the minimum free hose length is always used. Consult the hose manufacturer for their minimum free hose length recommendations. Hose assemblies should be installed in such a way that any motion or flexing occurs within the same plane.

2.14 Specifications and Standards: When selecting Hose, Tube and Fittings, government, industry, and Parker specifications and recommendations must be reviewed and followed as applicable.

2.15 Hose Cleanliness: Hose and Tube components may vary in cleanliness levels. Care must be taken to insure that the Hose and Tube Assembly selected has an adequate level of cleanliness for the application.

2.16 Fire Resistant Fluids: Some fire resistant fluids that are to be conveyed by Hose or Tube require use of the same type of Hose or Tube as used with petroleum base fluids. Some such fluids require a special Hose, Tube, Fitting and Seal, while a few fluids will not work with any Hose at all. See instructions 2.5 and 1.5. The wrong Hose, Tube, Fitting or Seal may fail after a very short service. In addition, all liquids but pure water may burn fiercely under certain conditions, and even pure water leakage may be hazardous.

2.17 Radiant Heat: Hose and Seals can be heated to destruction without contact by such nearby items as hot manifolds or molten metal. The same heat source may then initiate a fire. This can occur despite the presence of cool air around the Hose or Seal. Performance of Tube and Fitting subjected to the heat could be degraded.

2.18 Welding or Brazing: When using a torch or arc welder in close proximity to hydraulic lines, the hydraulic lines should be removed or shielded with appropriate fire resistant materials. Flame or weld spatter could burn through the Hose or Seal and possibly ignite escaping fluid resulting in a catastrophic failure. Heating of plated parts, including Hose Fittings and adapters, above 450°F (232°C) such as during welding, brazing or soldering may emit deadly gases. Any elastomer seal on fittings shall be removed prior to welding or brazing, any metallic surfaces shall be protected after brazing or welding when necessary. Welding and brazing filler material shall be compatible with the Tube and Fitting that are joined.

2.19 Atomic Radiation: Atomic radiation affects all materials used in Hose and Tube assemblies. Since the long-term effects may be unknown, do not expose Hose or Tube assemblies to atomic radiation. Nuclear applications may require special Tube and Fittings.

2.20 Aerospace Applications: The only Hose, Tube and Fittings that may be used for in-flight aerospace applications are those available from Parker's Stratoflex Products Division. Do not use any other Hose or Fittings for in-flight applications. Do not use any Hose or Fittings from Parker's Stratoflex Products Division with any other Hose or Fittings, unless expressly approved in writing by the engineering manager or chief engineer of Stratoflex Products Division and verified by the user's own testing and inspection to aerospace industry standards.

2.21 Unlocking Couplings: Ball locking couplings or other Fittings with quick disconnect ability can unintentionally disconnect if they are dragged over obstructions, or if the sleeve or other disconnect member, is bumped or moved enough to cause disconnect. Threaded Fittings should be considered where there is a potential for accidental uncoupling.

3.0 HOSE AND FITTINGS ASSEMBLY AND INSTALLATION INSTRUCTIONS

3.1 Component Inspection: Prior to assembly, a careful examination of the Hose and Fittings must be performed. All components must be checked for correct style, size, catalog number, and length. The Hose must be examined for cleanliness, obstructions, blisters, cover looseness, kinks, cracks, cuts or any other visible defects. Inspect the Fitting and sealing surfaces for burrs, nicks, corrosion or other imperfections. Do NOT use any component that displays any signs of nonconformance.

3.2 Hose and Fitting Assembly: Do not assemble a Parker Fitting on a Parker Hose that is not specifically listed by Parker for that Fitting, unless authorized in writing by the engineering manager or chief engineer of the appropriate Parker division. Do not assemble a Parker Fitting on another manufacturer's Hose or a Parker Hose on another manufacturer's Fitting unless (i) the engineering manager or chief engineer of the appropriate Parker division approves the Assembly in writing or that combination is expressly approved in the appropriate Parker literature for the specific Parker product, and

(ii) the user verifies the Assembly and the application through analysis and testing. For Parker Hose that does not specify a Parker Fitting, the user is solely responsible for the selection of the proper Fitting and Hose Assembly procedures. See instruction 1.4. To prevent the possibility of problems such as leakage at the Fitting or system contamination, it is important to completely remove all debris from the cutting operation before installation of the Fittings. The Parker published instructions must be followed for assembling the Fittings on the Hose. These instructions are provided in the Parker Fitting catalog for the specific Parker Fitting being used, or by calling 1-800-CPARKER, or at www.parker.com.

3.3 Related Accessories: Do not crimp or swage any Parker Hose or Fitting with anything but the listed swage or crimp machine and dies in accordance with Parker published instructions. Do not crimp

or swage another manufacturer's Fitting with a Parker crimp or swage die unless authorized in writing by the engineering manager or chief engineer of the appropriate Parker division.

3.4 Parts: Do not use any Parker Fitting part (including but not limited to socket, shell, nipple, or insert) except with the correct Parker mating parts, in accordance with Parker published instructions, unless authorized in writing by the engineering manager or chief engineer of the appropriate Parker division.

3.5 Field Attachable/Permanent: Do not reuse any field attachable Hose Fitting that has blown or pulled off a Hose. Do not reuse a Parker permanent Hose Fitting (crimped or swaged) or any part thereof. Complete Hose Assemblies may only be reused after proper inspection under section 4.0. Do not assemble Fittings to any previously used hydraulic Hose that was in service, for use in a fluid power application.

3.6 Pre-Installation Inspection: Prior to installation, a careful examination of the Hose Assembly must be performed. Inspect the Hose Assembly for any damage or defects. DO NOT use any Hose Assembly that displays any signs of nonconformance.

3.7 Minimum Bend Radius: Installation of a Hose at less than the minimum listed bend radius may significantly reduce the Hose life. Particular attention must be given to preclude sharp bending at the Hose to Fitting juncture. Any bending during installation at less than the minimum bend radius must be avoided. If any Hose is kinked during installation, the Hose must be discarded.

3.8 Twist Angle and Orientation: Hose Assembly installation must be such that relative motion of machine components does not produce twisting.

3.9 Securement: In many applications, it may be necessary to restrain, protect, or guide the Hose to protect it from damage by unnecessary flexing, pressure surges, and contact with other mechanical components. Care must be taken to insure such restraints do not introduce additional stress or wear points.

3.10 Proper Connection of Ports: Proper physical installation of the Hose Assembly requires a correctly installed port connection insuring that no twist or torque is transferred to the Hose when the Fittings are being tightened or otherwise during use.

3.11 External Damage: Proper installation is not complete without insuring that tensile loads, side loads, kinking, flattening, potential abrasion, thread damage or damage to sealing surfaces are corrected or eliminated. See instruction 2.10.

3.12 System Checkout: All air entrapment must be eliminated and the system pressurized to the maximum system pressure (at or below the Hose maximum working pressure) and checked for proper function and freedom from leaks. Personnel must stay out of potential hazardous areas while testing and using.

3.13 Routing: The Hose Assembly should be routed in such a manner so if a failure does occur, the escaping media will not cause personal injury or property damage. In addition, if fluid media comes in contact with hot surfaces, open flame or sparks, a fire or explosion may occur. See section 2.4.

3.14 Ground Fault Equipment Protection Devices (GFEEDs): WARNING! Fire and Shock Hazard. To minimize the danger of fire if the heating cable of a Multitube bundle is damaged or improperly installed, use a Ground Fault Equipment Protection Device. Electrical fault currents may be insufficient to trip a conventional circuit breaker. For ground fault protection, the IEEE 515: (www.ansi.org) standard for heating cables recommends the use of GFEEDs with a nominal 30 milliampere trip level for "piping systems in classified areas, those areas requiring a high degree of maintenance, or which may be exposed to physical abuse or corrosive atmospheres".

4.0 TUBE AND FITTINGS ASSEMBLY AND INSTALLATION INSTRUCTIONS

4.1 Component Inspection: Prior to assembly, a careful examination of the Tube and Fittings must be performed. All components must be checked for correct style, size, material, seal, and length. Inspect the Fitting and sealing surfaces for burrs, nicks, corrosion, missing seal or other imperfections. Do NOT use any component that displays any signs of nonconformance.

4.2 Tube and Fitting Assembly: Do not assemble a Parker Fitting with a Tube that is not specifically listed by Parker for that Fitting, unless authorized in writing by the engineering manager or chief engineer of the appropriate Parker division. The Tube must meet the requirements specified to the Fitting. The Parker published instructions must be followed for assembling the Fittings to a Tube. These instructions

are provided in the Parker Fitting catalog for the specific Parker Fitting being used, or by calling 1-800-CPARKER, or at www.parker.com.

4.3 Related Accessories: Do not preset or flange Parker Fitting components using another manufacturer's equipment or procedures unless authorized in writing by the engineering manager or chief engineer of the appropriate Parker division. Tube, Fitting component and tooling must be checked for correct style, size and material. Operation and maintenance of Related Accessories must be in accordance with the operation manual for the designated Accessory.

4.4 Securement: In many applications, it may be necessary to restrain, protect, or guide the Tube to protect it from damage by unnecessary flexing, pressure surges, vibration, and contact with other mechanical components. Care must be taken to insure such restraints do not introduce additional stress or wear points.

4.5 Proper Connection of Ports: Proper physical installation of the Tube Assembly requires a correctly installed port connection insuring that no torque is transferred to the Tube when the Fittings are being tightened or otherwise during use.

4.6 External Damage: Proper installation is not complete without insuring that tensile loads, side loads, flattening, potential abrasion, thread damage or damage to sealing surfaces are corrected or eliminated. See instruction 2.10.

4.7 System Checkout: All air entrapment must be eliminated and the system pressurized to the maximum system pressure (at or below the Tube Assembly maximum working pressure) and checked for proper function and freedom from leaks. Personnel must stay out of potential hazardous areas while testing and using.

Routing: The Tube Assembly should be routed in such a manner so if a failure does occur, the escaping media will not cause personal injury or property damage. In addition, if fluid media comes in contact with hot surfaces, open flame or sparks, a fire or explosion may occur. See section 2.4.

5.0 HOSE AND FITTING MAINTENANCE AND REPLACEMENT INSTRUCTIONS

5.1 Even with proper selection and installation, Hose life may be significantly reduced without a continuing maintenance program. The severity of the application, risk potential from a possible Hose failure, and experience with any Hose failures in the application or in similar applications should determine the frequency of the inspection and the replacement for the Products so that Products are replaced before any failure occurs. Certain products require maintenance and inspection per industry requirements. Failure to adhere to these requirements may lead to premature failure. A maintenance program must be established and followed by the user and, at minimum, must include instructions 5.2 through 5.7.

5.2 Visual Inspection Hose/Fitting: Any of the following conditions require immediate shut down and replacement of the Hose Assembly:

- Fitting slippage on Hose;
- Damaged, cracked, cut or abraded cover (any reinforcement exposed);
- Hard, stiff, heat cracked, or charred Hose;
- Cracked, damaged, or badly corroded Fittings;
- Leaks at Fitting or in Hose;
- Kinked, crushed, flattened or twisted Hose; and
- Blistered, soft, degraded, or loose cover.

5.3 Visual Inspection All Other: The following items must be tightened, repaired, corrected or replaced as required:

- Leaking port conditions;
- Excess dirt buildup;
- Worn clamps, guards or shields; and
- System fluid level, fluid type, and any air entrapment.

5.4 Functional Test: Operate the system at maximum operating pressure and check for possible malfunctions and leaks. Personnel must avoid potential hazardous areas while testing and using the system. See section 2.2.

5.5 Replacement Intervals: Hose assemblies and elastomeric seals used on Hose Fittings and adapters will eventually age, harden, wear and deteriorate under thermal cycling and compression set. Hose Assemblies and elastomeric seals should be inspected and replaced at specific replacement intervals, based on previous service life, government or industry recommendations, or when failures could result in unacceptable downtime, damage, or injury risk. See section 1.2. Hose and Fittings may be subjected to internal mechanical and/or chemical wear from the conveying fluid and may fail without warning. The user must determine the product life under such circumstances by testing. Also see section 2.5.

5.6 Hose Inspection and Failure: Hydraulic power is accomplished by utilizing high pressure fluids to transfer energy and do work. Hoses, Fittings and Hose Assemblies all contribute to this by transmitting fluids at high pressures. Fluids under pressure can be dangerous and potentially lethal and, therefore, extreme caution must be exercised when working with fluids under pressure and handling the Hoses transporting the fluids. From time to time, Hose Assemblies will fail if they are not replaced at proper time intervals. Usually these failures are the result of some form of misapplication, abuse, wear or failure to perform proper maintenance. When Hoses fail, generally the high pressure fluids inside escape in a stream which may or may not be visible to the user. Under no circumstances should the user attempt to locate the leak by "feeling" with their hands or any other part of their body. High pressure fluids can and will penetrate the skin and cause severe tissue damage and possibly loss of limb. Even seemingly minor hydraulic fluid injection injuries must be treated immediately by a physician with knowledge of the tissue damaging properties of hydraulic fluid.

If a Hose failure occurs, immediately shut down the equipment and leave the area until pressure has been completely released from the Hose Assembly. Simply shutting down the hydraulic pump may or may not eliminate the pressure in the Hose Assembly. Many times check valves, etc., are employed in a system and can cause pressure to remain in a Hose Assembly even when pumps or equipment are not operating. Tiny holes in the Hose, commonly known as pinholes, can eject small, dangerously powerful but hard to see streams of hydraulic fluid. It may take several minutes or even hours for the pressure to be relieved so that the Hose Assembly may be examined safely. Once the pressure has been reduced to zero, the Hose Assembly may be taken off the equipment and examined. It must always be replaced if a failure has occurred. Never attempt to patch or repair a Hose Assembly that has failed. Consult the nearest Parker distributor or the appropriate Parker division for Hose Assembly replacement information. Never touch or examine a failed Hose Assembly unless it is obvious that the Hose no longer contains fluid under pressure. The high pressure fluid is extremely dangerous and can cause serious and potentially fatal injury.

5.7 Elastomeric seals: Elastomeric seals will eventually age, harden, wear and deteriorate under thermal cycling and compression set. Elastomeric seals should be inspected and replaced.

5.8 Refrigerant gases: Special care should be taken when working with refrigeration systems. Sudden escape of refrigerant gases can cause blindness if the escaping gases contact the eye and can cause freezing or other severe injuries if it contacts any other portion of the body.

5.9 Compressed natural gas (CNG): Parker CNG Hose Assemblies should be tested after installation and before use, and at least on a monthly basis per instructions provided on the Hose Assembly tag. The recommended procedure is to pressurize the Hose and check for leaks and to visually inspect the Hose for damage and to perform an electrical resistance test.

Caution: Matches, candles, open flame or other sources of ignition shall not be used for Hose inspection. Leak check solutions should be rinsed off after use.

6.0 HOSE STORAGE

6.1 Age Control: Hose and Hose Assemblies must be stored in a manner that facilitates age control and first-in and first-out usage based on manufacturing date of the Hose and Hose Assemblies. Unless otherwise specified by the manufacturer or defined by local laws and regulations:

6.1.1 The shelf life of rubber hose in bulk form or hose made from two or more materials is 28 quarters (7 years) from the date of manufacture, with an extension of 12 quarters (3 years), if stored in accordance with ISO 2230;

6.1.2 The shelf life of thermoplastic and polytetrafluoroethylene hose is considered to be unlimited;

6.1.3 Hose assemblies that pass visual inspection and proof test shall not be stored for longer than 2 years.

6.1.4 Storage: Stored Hose and Hose Assemblies must not be subjected to damage that could reduce their expected service life and must be placed in a cool, dark and dry area with the ends capped. Stored Hose and Hose Assemblies must not be exposed to temperature extremes, ozone, oils, corrosive liquids or fumes, solvents, high humidity, rodents, insects, ultraviolet light, electromagnetic fields or radioactive materials.

Technical information
Technical Overview Hose by Inside Diameter

Part number #	Size					Max. working pressure		Min. burst pressure		Min. bend radius		Weight		Nipple ID after crimping		Ferrule OD after crimping		DF
	size	mm	inch	mm	inch	MPa	psi	MPa	psi	mm	inch	kg/m	lbs/ft	mm	inch	mm	inch	
DN3																		
2240D-02V32-TC	-02	3.0	1/8	7.0	0.276	110.0	15.950	275.0	39.875	60	2.36	0.07	0.05	1.60	0.06	9.10	0.36	2.5
2240D-02V62-HT-TC	-02	3.0	1/8	7.0	0.276	110.0	15.950	275.0	39.875	60	2.36	0.07	0.05	1.5	0.06	9.0	0.36	2.5
2440D-02V32	-02	3.0	1/8	7.9	0.311	207.0	30.000	518.0	75.000	100	3.94	0.12	0.08	1.50	0.06	9.80	0.39	2.5
2440D-02V32-TC	-02	3.0	1/8	7.9	0.311	207.0	30.000	518.0	75.000	100	3.94	0.12	0.08	1.50	0.06	9.80	0.39	2.5
DN4																		
2380N-025V10	-025	4.0	5/32	9.7	0.382	75.0	10.875	300.0	43.500	55	2.17	0.16	0.11	2.30	0.09	13.00	0.51	4.0
2240D-025V32-TC	-025	4.0	5/32	7.7	0.303	120.0	17.400	300.0	43.500	75	2.95	0.10	0.07	2.30	0.09	9.90	0.39	2.5
2240D-025V62-HT-TC	-025	4.0	5/32	7.7	0.303	120.0	17.400	300.0	43.500	75	2.95	0.10	0.07	2.2	0.087	9.9	0.390	2.5
2380N-025V10W	-025	4.0	5/32	9.7	0.382	140.0	20.300	350.0	50.750	55	2.17	0.16	0.11	2.10	0.08	13.00	0.51	2.5
2248D-025V32-TC	-025	4.0	5/32	7.9	0.311	150.0	21.750	375.0	54.375	75	2.95	0.11	0.07	2.30	0.09	9.80	0.39	2.5
2248D-025V62-HT-TC	-025	4.0	5/32	7.9	0.311	150.0	21.750	375.0	54.375	75	2.95	0.11	0.07	2.2	0.087	9.8	0.386	2.5
2440D-025V32	-025	4.0	5/32	10.4	0.409	220.0	31.900	550.0	79.750	100	3.94	0.21	0.14	1.40	0.06	14.60	0.57	2.5
2440D-025V32-TC	-025	4.0	5/32	10.4	0.409	220.0	31.900	550.0	79.750	100	3.94	0.21	0.14	1.40	0.06	14.60	0.57	2.5
2448D-025V32-TC	-025	4.0	5/32	9.9	0.39	301.0	43.640	650.0	94.240	100	3.94	0.21	0.14	1.80	0.07	12.80	0.50	2.0
PFX30-025	-025	4,0	5/32	12,0	0,472	301	43645	700	101500	140	5,51	0,29	0,195	1,8	0,071	16,3	0,642	2,3
DN5																		
2240D-03V32-TC	-03	5.0	3/16	9.5	0.374	110.0	15.950	250.0	36.250	95	3.74	0.13	0.09	2.80	0.11	12.00	0.47	2.5
2240D-03V62-HT-TC	-03	5.0	3/16	9.5	0.374	110.0	15.950	275	36.250	95	3.74	0.13	0.09	2.0	0.079	12	0.472	2.5
2248D-03V32-TC	-03	5.0	3/16	9.5	0.374	140.0	20.300	350.0	50.750	95	3.74	0.14	0.09	2.8	0.11	12.1	0.48	2.5
2248D-03V62-HT-TC	-03	5.0	3/16	9.5	0.374	140.0	20.300	350.0	50.750	95	3.74	0.14	0.09	2.7	0.106	12.1	0.476	2.5
2440D-03V32	-03	5.0	3/16	11.5	0.453	180.0	26.100	450.0	65.250	130	5.12	0.28	0.19	1.40	0.06	15.30	0.60	2.5
2440D-03V32-TC	-03	5.0	3/16	11.5	0.453	180.0	26.100	450.0	65.250	130	5.12	0.28	0.19	1.40	0.06	15.30	0.60	2.5
2640D-03V32	-03	5.0	3/16	13.0	0.512	250.0	36.250	625.0	90.625	175	6.89	0.41	0.28	2.30	0.09	18.60	0.73	2.5
PFX30-03	-03	4.8	3/16	13.3	0,524	301	43645	700	101.500	200	7.87	0.47	0.316	2.2	0.087	18.8	0.740	2.3
PFX30-03-TJ	-03	4.8	3/16	17.3	0,681	301	43645	700	101.500	200	7.87	0.58	0.390	2.2	0.087	22.3	0.878	2.3
PFX40-03	-03	4.8	3/16	15.1		400	58000	800	116.000	200	0.64							
PFX40-03-TJ	-03	4.8	3/16	19.1		400	58000	800	116.000	200	0.77							
DN6																		
2022N-04V15-10K	-04	6.0	1/4	13.8	0.543	69.0	10.000	276.0	40.000	100	3.94	0.14	0.0944	3.50	0.14	18.50	0.72	4.0
2380N-04V00	-04	6.0	1/4	13.4	0.524	70.0	10.150	280.0	40.600	70	2.76	0.27	0.18	3.60	0.14	16.60	0.73	4.0
2388N-04V00	-04	6.0	1/4	13.4	0.524	80.0	11.600	320.0	46.400	80	3.15	0.30	0.20	3.60	0.14	16.80	0.72	4.0
2240D-04V32-TC	-04	6.0	1/4	11.5	0.453	110.0	15.950	275.0	39.875	110	4.33	0.20	0.13	3.80	0.15	13.60	0.54	2.5
2380N-04V00W	-04	6.0	1/4	13.4	0.524	110.0	15.950	280.0	40.600	70	2.76	0.28	0.19	3.80	0.15	18.00	0.71	2.5
2240D-04V62-HT-TC	-04	6.0	1/4	11.5	0.453	110.0	15.950	275.0	39.875	110	4.33	0.20	0.13	3.7	0.146	13.6	0.535	2.5
2388N-04V12W	-04	6.0	1/4	13.4	0.524	128.0	18.560	320.0	46.400	80	3.15	0.30	0.20	3.60	0.14	18.20	0.72	2.5
2440D-04V32	-04	6.0	1/4	12.5	0.492	164.0	23.780	410.0	59.450	155	6.10	0.33	0.22	2.90	0.11	17.00	0.67	2.5
2440D-04V32-TC	-04	6.0	1/4	12.5	0.492	164.0	23.780	410.0	59.450	155	6.10	0.33	0.22	2.90	0.11	17.00	0.67	2.5
2640D-04V32	-04	6.0	1/4	14.6	0.575	250.0	36.250	625.0	90.625	200	7.87	0.64	0.43	3.20	0.13	19.60	0.77	2.5
DN8																		
2380N-05V00	-05	8.0	5/16	15.8	0.622	62.5	9.060	250.0	36.250	90	3.54	0.35	0.24	4.80	0.19	20.10	0.79	4.0
2248D-05V32-TC	-05	8.0	5/16	13.4	0.528	100.0	14.500	250.0	36.250	120	4.72	0.25	0.17	4.80	0.19	16.10	0.63	2.5
2380N-05V00W	-05	8.0	5/16	15.8	0.622	100.0	14.500	250.0	36.250	90	3.54	0.35	0.24	4.90	0.19	20.00	0.79	2.5
2440D-05V32	-05	8.0	5/16	15.1	0.594	150.0	21.750	375.0	54.375	175	6.89	0.44	0.30	3.70	0.15	21.00	0.83	2.5
2440D-05V32-TC	-05	8.0	5/16	15.1	0.594	150.0	21.750	375.0	54.375	175	6.89	0.44	0.30	3.70	0.15	21.00	0.83	2.5

Technical information



Part number #	Size				Max. working pressure		Min. burst pressure		Min. bend radius		Weight		Nipple ID after crimping		Ferrule OD after crimping		DF	
	size	mm	inch	mm	inch	MPa	psi	MPa	psi	mm	inch	kg/m	lbs/ft	mm	inch	mm		inch
DN8																		
PFX25-025	-025	4.0	5/32	9.9	0.390	250	36250	625	90625	120	4.72	0.22	0.148	1.3	0.051	14.1	0.555	2.5
PFX25-03	-03	4.9	3/16	12.9	0.508	250	36250	625	90625	175	6.89	0.41	0.276	2.2	0.087	18.8	0.740	2.5
PFX25-04	-04	6.4	1/4	14.6	0.575	250	36250	625	90625	200	7.87	0.55	0.370	3.1	0.122	19.5	0.768	2.5
PFX25-05	-05	8.0	5/16	18	0.708	250	36.250	625	90.625	200	7.87	0.85	0.57	3.6	0.142	22.8	0.898	2.5
PFX25-05-TJ	-05	8.0	5/16	22	0.866	250	36.250	625	90.625	200	7.87	1.00	0.67	3.6	0.142	26.5	1.043	2.5
PFX30-05	-05	8.0	5/16	18.7	0.736	301	43.645	700	101.500	230	9.055	0.96	0.65	3.6	0.142	23.3	0.917	2.3
PFX30-05-TJ	-05	8.0	5/16	22.7	0.893	301	43.645	700	101.500	230	9.055	1.11	0.75	3.6	0.142	27	1.063	2.3
PFX38-05	-05	8.0	5/16	20.5	0.807	380	55.100	760	111.200	280	11.02	1.26	0.85	3.5	0.138	24.6	0.969	2.0
PFX38-05-TJ	-05	8.0	5/16	24.5	0.964	380	55.100	760	111.200	280	11.02	1.43	0.96	3.5	0.138	28.3	1.114	2.0
DN10																		
2244N-06V00	-06	10.0	3/8	18.0	0.709	53.5	7.755	215.0	31.175	120	4.72	0.50	0.34	6.80	0.27	23.80	0.94	4.0
2380N-06V10	-06	10.0	3/8	17.9	0.705	57.5	8.337	230.0	33.350	120	4.72	0.44	0.30	6.70	0.26	23.40	0.92	4.0
2022N-06V15-10K	-06	10.0	3/8	19.0	0.748	69.0	10.000	276.0	40.000	100	3.94	0.24	0.16	5.30	0.21	23.20	0.91	4.0
2388N-06V12	-06	10.0	3/8	19.8	0.779	72	10.440	288.0	41.760	100	3.93	0.65	0.43	5.6	0.22	23.5	0.925	4.00
2380N-06V10W	-06	10.0	3/8	17.9	0.705	92	13.340	230.0	33.350	120	4.72	0.44	0.30	5.50	0.22	22.7	0.89	2.5
2388N-06V12W	-06	10.0	3/8	19.8	0.779	125	18.125	312.5	45.310	100	3.93	0.65	0.43	5.6	0.22	23.5	0.925	2.50
2440N-06V30	-06	10.0	3/8	19.4	0.764	140.0	20.300	350.0	50.750	190	7.48	0.73	0.49	5.50	0.22	26.90	1.06	2.5
2580N-06V12	-06	10.0	3/8	21.6	0.850	160.0	23.200	400.0	58.000	95	3.74	0.94	0.63	5.50	0.22	28.50	1.12	2.5
PFX30-06	-06	10.0	3/8	22.7	0.894	301	43.645	625	90.625	250	9.84	1.35	0.907	5.2	0.20	27.3	1.075	2.08
PFX30-06-TJ	-06	10.0	3/8	26.7	1.051	301	43.645	625	90.625	250	9.84	1.53	1.028	5.2	0.20	31.0	1.220	2.08
DN12																		
2244N-08V10	-08	12.0	1/2	22.7	0.894	55.0	7.975	220.0	31.900	150	5.91	0.80	0.54	8.80	0.35	29.50	1.16	4.0
2380N-08V10	-08	12.0	1/2	22.9	0.902	55.0	7.975	220.0	31.900	150	5.91	0.68	0.46	6.60	0.26	30.00	1.18	4.0
2022N-08V15-10K	-08	12.0	1/2	23.0	0.906	69.0	10.000	276.0	40.000	100	3.94	0.34	0.23	6.50	0.26	30.50	1.20	4.0
2380N-08V10W	-08	12.0	1/2	22.9	0.902	88.0	12.760	220.0	31.900	150	5.91	0.68	0.46	6.30	0.25	30.2	1.19	2.5
2388N-08V12W	-08	12.0	1/2	23.0	0.906	110.0	15.950	275.0	39.875	100	3.94	0.80	0.54	7.50	0.30	28.50	1.12	2.5
2440N-08V30	-08	12.0	1/2	22.5	0.886	140.0	20.300	350.0	50.750	200	7.87	0.94	0.63	6.70	0.26	30.70	1.21	2.5
2580N-08V12	-08	12.0	1/2	25.0	0.984	140.0	20.300	350.0	50.750	110	4.33	1.19	0.80	7.50	0.30	30.50	1.20	2.5
2640N-08V32	-08	12.0	1/2	24.5	0.965	180.0	26.100	450.0	65.250	290	11.42	1.36	0.91	6.80	0.27	34.00	1.34	2.5
PFX21-08	-08	12.0	1/2	27.1	1.066	210	30.450	525.0	76.125	300	11.81	1.85	1.24	7.0	0.27	33.4	1.315	2.5
PFX21-08-TJ	-08	12.0	1/2	31.7	1.248	210	30.450	525.0	76.125	300	11.81	2.06	1.38	7.0	0.27	37.5	1.476	2.5
PFX30-08	-08	12.0	1/2	29.9	1.177	301	43.645	625.0	90.625	350	13.77	2.48	1.66	6.7	0.26	35.0	1.378	2.08
PFX30-08-TJ	-08	12.0	1/2	34.0	1.33	301	43.645	625.0	90.625	350	13.77	2.72	1.82	6.7	0.26	39.0	1.535	2.08
DN20																		
2440N-12V30	-12	20.0	3/4	30.0	1.181	100.0	14.500	250.0	36.250	250	9.84	1.39	0.93	12.70	0.50	38.50	1.52	2.5
2580N-12V12	-12	20.0	3/4	32.6	1.283	120.0	17.400	300.0	43.500	170	6.69	1.76	1.18	12.50	0.49	39.80	1.57	2.5
2640N-12V32	-12	20.0	3/4	33.0	1.299	140.0	20.300	350.0	50.750	350	13.78	2.10	1.41	12.40	0.49	40.60	1.60	2.5
2648N-12V32	-12	20.0	3/4	33.7	1.327	160.0	23.200	400.0	58.000	350	13.78	2.28	1.53	12.50	0.49	41.10	1.62	2.5
DN25																		
2440N-16V30	-16	25.0	1	37.0	1.457	90.0	13.050	225.0	32.625	300	11.81	2.00	1.34	17.20	0.68	45.30	1.78	2.5
2640N-16V32	-16	25.0	1	40.0	1.575	120.0	17.400	300.0	43.500	400	15.75	2.90	1.95	17.30	0.68	49.00	1.93	2.5
2648N-16V32	-16	25.0	1	40.8	1.606	150.0	21.750	375.0	54.375	400	15.75	3.10	2.08	16.50	0.65	49.00	1.93	2.5
DN32																		
2380N-20V30	-20	31.8	1 1/4	44.0	1.732	27.5	3.990	110.0	15.950	400	15.75	1.83	1.23	24.90	0.98	49.40	1.94	4.0

General remark on column **DF** in the tables:

Ultra high pressure hoses are normally used with a design factor of 2.5:1 for working pressures up to 300.0 MPa acc. to ISO 7751 and a design factor of 2:1 for working pressures \geq 300.0 MPa acc. to EN1829-2. For hydraulic hoses, a design factor of 4:1 applies.

Chapter G**Index of part numbers**

Part number	page	Part number	page
1018X-1-04	B-15, B-22	101LX-6-05	C-32
1018X-2-025	B-11, B-15	101LX-6-05C	C-32
1018X-2-04	B15, B22	101LX-6-06	C-32
1018X-4-025	B-11, B-15	101LX-6-06C	C-32
1018X-4-04	B4, B15, B-22	101LX-8-06	C-32
1018X-4-04C	B4, B15, B-22	101LX-8-06C	C-32
1018X-6-04	B4, B15, B-22	101LX-8-08	B4, B-15, C14, C-32
1018X-6-04C	B4, B15, B-22	101LX-8-08C	B4, B-15, C-32
1018X-6-05	B-15	101LX-12-12	C-32
1018X-6-05C	B-15	101LX-16-16	C-32
1018X-6-06	B-11, B15	101TX-1-02-PL	C-10
1018X-6-06C	B-11, B15	101TX-1-025-PL	C-10
1018X-8-06	B-11, B15	101TX-2-02-PL	C-10
1018X-8-06C	B-11, B15	101TX-2-025-PL	C-10
1018X-8-08	B-11, B15	101TX-2-03-PL	C-10
1018X-8-08C	B-11, B15	101TX-2-04-PL	C-10
101BL-12-12	C-22	101TX-4-025-PL	C-10
101BL-6-06	C-22	101TX-4-03-PL	C-10
101BL-8-08	C-22	101TX-4-04-PL	C-10
101BL-8-08C	C-22	101TX-4-05-PL	C-10
101BS-8-08	C-20	101TX-6-05-PL	C-10
101BS-6-06	C-20	102TX-1-025-PL	C-10
101KY-2-04	C-14	102TX-1-03-PL	C-10
101KY-4-04	C-14, C20	102TX-2-03W	C-10
101KY-4-05	C-14	102TX-4-04-PL	C-10
101KY-6-05	C-14	1058X-4-04	B-16, B-22
101LX-12-12	C-32	1058X-6-04	B-16, B-22
101LX-16-16	C-32	1063X-6-06C	B-3
101LX-4-03	C-32	1068X-10-08	B-12
101LX-4-03C	C-32	1068X-4-04C	B3, B16, B-23
101LX-4-04	C-32	1068X-4-4	B3, B16, B-23
101LX-4-04C	C-32	1068X-5-04	B3, B16, B-23
101LX-4-05	C-32	1068X-5-04C	B3, B16, B-23
101LX-4-05C	C-32	1068X-6-04C	B3, B16, B-23
101LX-6-04	C-32	1068X-6-05	B16
101LX-6-04C	C-32	1068X-6-05C	B16

Table of contents

Part number	page	Part number	page
1068X-6-06	B-12, B16	1928X-6-06	B-9, B-17
1068X-6-06C	B3, B-12, B-16	1928X-6-06C	B9, B-17
1068X-6-04	B3, B-16, B-23	1928X-8-06	B3, B-9, B-17, B23
1068X-8-06	B-12	1928X-8-06C	B-17
1068X-8-08	B-12	1928X-8-08	B3, B-9, B-23
1068X-8-08C	B-12	192BC-8-06	C-22
106LX-8-08	B-3, B-16	192BL-16-12	C-22
106LX-8-08C	B-3, B-16	192BL-6-06	C-22
106TX-4-025W	C-8	192BL-8-08	C-22
106TX-6-03W	C-8	192BL-8-08C	C-22
106TX-6-04W	C-8	192BS-8-08	C-18
1078X-4-04	B-18, B-25	192BS-6-06	B-23, C18
1078X-4-04C	B-18	192BS-8-06	B-23, C18
1078X-6-06	B-13, B-18	192EH-12-12	C-3, C-5
1078X-8-08	B-13	192EH-8-08	C-3, C-5
10C8X-12-06	B-8	192ES-16-16	C-3, C-5
10C8X-14-06	B-8	192ES-20-20	C-3, C-5
10C8X-16-08	B-8	192KY-6-05	C-14
11C8X-14-06	B-8	192KY-8-06	C-14
11C8X-16-08	B-8	192LX-12-08C	B-3, C-29
13B8X-4-025	B-11, B-19	192LX-16-12	C-29
13B8X-4-04	B-19, B-26	192LX-16-12C4462	C-29
13B8X-6-04	B-19, B-26	192LX-20-16	C-29
13B8X-6-05	B-19	192LX-4-03	C-29
13B8X-6-06	B-11, B-19	192LX-4-03C	C-29
13B8X-6-06C	B-11	192LX-6-05	C-29
13B8X-8-06	B-11, B19, B-23	192LX-6-05C	C-29
13B8X-8-06C	B-11	192LX-8-06	C-29
13B8X-8-08	B-11	192LX-8-06C	C-29
13B8X-8-08C	B-11	192LX-8-08	B-3, B-17, C-29
13BNX-24-20	B-23	192LX-8-08C	B-3, B-17
16Y2X-4-025	C-58	1AY2X-10-05	C-55, C-63, C-60
16Y2X-4-025C	C-58	1AY2X-13-05	C-55, C-63, C-60
16Y2X-4-03	C-44, C-67	1AY2X-13-05C	C-55, C-63, C-60
1922X-4-025	C-58	1AY2X-6-025	C-43, C-58
1922X-4-03	C-44, C-58, C-67	1AY2X-6-025C	C-43, C-58
1923X-8-06C	B-3	1AY2X-6-03	C-43, C-56, C-58, C-67
1925X-4-03	C-47	1AY2X-6-03C	C-43, C-56, C-58
1928X-4-025	B-9, B-17	1AY2X-8-05	C-43, C-55, C-60, C-63
1928X-4-04	B3, B-17, B-23	1AY2X-8-06	C-60
1928X-4-04C	B3, B-17, B-23	1AY2X-11-08	C-43, C-51, C-60

Part number	page	Part number	page
1AY2X-11-08C	C-43	1C3LX-8-025	C-30
1AY5X-11-08	C-46	1C3LX-8-03	C-30
1AY5X-16-12	C-46	1C3LX-8-03C	C-30
1AY5X-6-03	C-46	1C3LX-8-04	C-30
1AY8X-6-025	C-15	1C3LX-8-04C	C-30
1AY8X-6-04	B-18, B-24	1C68X-16-08	B-7
1AY8X-8-06	B-24	1C6LX-12-05	C-31
1AYBL-11-06	C-23	1C92X-12-05	C-55, C-60, C-63
1AYBL-11-08	C-23	1C92X-12-06	C-60
1AYBL-11-08C	C-23	1C92X-16-06	C-60
1AYBS-8-06	B-24, C-19	1C92X-16-08	C-43, C-52, C-60
1AYBS-11-08	C-28	1C92X-16-08C	C-43
1AYCX-16-16	C-49	1C93X-14-06C	B-4
1AYJX-16-12W	C-43, C-49	1C93X-16-06C	B-4
1AYJX-16-12C	C-43	1C95X-16-08	C-46
1AYKY-6-04	C-15, C-19	1C95X-25-12	C-46
1AYKY-8-05	C-15	1C98X-10-04	B-7, B-20, B-26
1AYLX-11-08	C-15, C-27	1C98X-10-04C	B-7, B-20, B-26
1AYLX-11-08C	C-27	1C98X-12-04	B-7, B-20, B-26
1AYLX-16-12	C-27	1C98X-12-05	B-22
1AYLX-6-025	C-27	1C98X-12-06	B-7, B-20
1AYLX-6-02	C-27	1C98X-12-06C	B-7, B-24
1AYLX-6-03	C-27	1C98X-14-06	B-7, B-20
1AYLX-6-03C	C-27	1C98X-14-06C	B-20
1AYLX-6-04	C-27	1C98X-16-05	B-24
1AYLX-6-04C	C-27	1C98X-16-08	B-7
1AYLX-8-05	C-27	1C98X-16-08C	B-7
1AYLX-8-05C	C-27	1C98X-8-025	B-7, B-20, C-15
1AYLX-8-06	C-27	1C98X-8-025C	B7, B-20, C-20
1AYLX-8-06C	C-27	1C98X-8-04	B-7, B-20, B-26
1AYLX-16-12C4462	C-27	1C98X-8-04C	B-7, B-20, B-26
1AYTX-6-025W	C-8	1C9BL-14-06	C-23
1AYTX-6-02W	C-8	1C9BL-14-08	C-23
1AYTX-6-03W	C-8	1C9BL-14-08C	C-23
1AYTX-6-04W	C-8	1C9BL-16-06	C-23
1AYTX-8-05W	C-8	1C9BL-16-08	C-23
1AYTX-8-025W	C-8	1C9BL-16-08C	C-23
1AYTX-8-03W	C-8	1C9BL-25-12	C-23
1C35X-8-03	C-46	1C9BS-12-06	B-26, C-18
1C38X-12-06	B-6	1C9BS-14-06	B-26, C-18
1C38X-15-08	B-6	1C9BS-14-08	C-18

Table of contents

Part number	page	Part number	page
1C9BS-16-06	B-26, C-18	1C9TX-16-05W	C-19
1C9BS-16-08	C-18	1D28X-14-06	B-9
1C9BS-25-08	C-18	1D28X-16-08	B-9
1C9CX-30-16W	C-49	1D98X-4-025	B-17
1C9JX-16-08W	C-43	1D98X-4-04C	B-17, B-24
1C9JX-25-12W	C-43, C-49	1D98X-4-04	B-17, B-24
1C9JX-25-12C	C-43	1D98X-6-04	B-17
1C9JX-30-16W	C-49	1D98X-6-06	B-17
1C9KY-10-04	C-15	1D9EH-12-12	C-3, C-5
1C9KY-12-05	C-15	1D9EH-8-08	C-3, C-5
1C9KY-14-05	C-15	1D9ES-16-16	C-3, C-5
1C9KY-14-06	C-15	1D9ES-20-20	C-3, C-5
1C9KY-16-04	C-15	1D9KY-4-04	C-19
1C9KY-16-05	C-15	1D9LX-4-025	C-30
1C9LX-10-04	C-26	1D9LX-4-03	C-30
1C9LX-12-05	C-26	1D9LX-4-04	C-30
1C9LX-12-06	C-26	1D9LX-4-05	C-30
1C9LX-14-05	C-26	1D9LX-4-06	C-30
1C9LX-14-06	C-26	1D9LX-8-08	B-17
1C9LX-14-06C	C-26	1MR2X-12-03	C-45, C-47
1C9LX-16-03	C-26	1MR2X-6-03	C-45, C-47
1C9LX-16-04	C-26	1MR2X-8-03	C-45, C-47
1C9LX-16-05	C-26	1MR2X-10-03	C-45, C-47
1C9LX-16-05C	C-26	1MR2X-12-03	C-45, C-47
1C9LX-16-06	C-26	1MR2X-6-025	C-45, C-47
1C9LX-16-06C	C-26	1MR2X-8-025	C-45, C-47
1C9LX-16-08	B-4, B-20, C-15, C-26	1MR2X-10-025	C-45, C-47
1C9LX-16-08C	B-4, B-20, C-26	1MRLX-6-02	C-31
1C9LX-25-12	C-26	1MRLX-6-02	C-31
1C9LX-25-12C4462	C-26	1MRLX-8-025	C-31
1C9LX-30-16	C-26	1MRLX-6-03	C-31
1C9LX-30-16C4462	C-26	1MRLX-8-03	C-31
1C9LX-8-025	C-26	1TM2X-8-03-HPK	C-45, D-5
1C9NX-38-20	B-20	1TM2X-8-05-HPK	C-61, C-64, D-5
1C9TX-10-04W	C-19	1TM2X-9-08-HPK	C-45, C-52, C-61, D-5
1C9TX-12-05W	C-19	1TMBL-9-08-HPK	C-31, D-5
1C9TX-14-05W	C-19	1TMBS-8-05-HPK	C-23
1C9TX-16-025W	C-19	1TMBS-9-08-HPK	C-28, D-5
1C9TX-16-02W	C-19	1TMKY-8-05-HPK	D-5, C-16
1C9TX-16-03W	C-19	1U08X-4-04	B-19, B-25
1C9TX-16-04W	C-19	1U08X-4-04C2W	B-25

Part number	page	Part number	page
1U08X-6-04	B-19, B-25	1Y42X-6-03	C-41, C-57, C-66
1U08X-6-04C2W	B-25	1Y42X-6-03C	C-41, C-57, C-66
1U08X-6-05	B-19, B-23	1Y42X-6-04	C-41
1U08X-6-06	B-19, B-10	1Y42X-6-05	C-54, C-61, C-63
1U08X-8-06	B-19, B-10	1Y42X-9-03	C-41, C-57, C-66
1U08X-8-08	B-10	1Y42X-9-03C	C-41, C-57, C-66
1U0KY-4-04	C-14, C-18	1Y42X-9-04	C-41
1U0TX-2-02W	C-9	1Y42X-9-05	C-54, C-63
1U0TX-4-025W	C-9	1Y42X-9-06	C-61
1U0TX-4-02W	C-9	1Y42X-9-08	C-41, C-51, C-61
1U0TX-4-03W	C-9	1Y42X-16-08	C-41, C-51, C-61
1U0TX-4-04W	C-9	1Y4KY-9-05	C-16
1U0TX-6-05W	C-9	1Y4LX-9-08	C-66, C-28
1Y2CX-16-16	C-49	1Y4LX-9-08C	C-28
1Y2JX-16-12W	C-49	1Y9LX-4-03	C-29
1Y2JX-16-12	C-44	1Y9LX-4-03C	C-29
1Y2JX-16-12C	C-44	1Y9LX-6-05	C-29
1Y2JX-16-16W	C-44	1Y9LX-8-08	C-29
1Y2LX-6-025	C-36	1YA5X-1-03	C-47
1Y2LX-6-03	C-36	1YA5X-3-03	C-47
1Y2LX-6-03C	C-36	1YALX-1-025	C-28
1Y2LX-6-04	C-36	1YALX-1-025C	C-28
1Y2LX-6-04C	C-36	1YALX-1-03	C-28
1Y2LX-6-05C	C-36	1YALX-1-03C	C-28
1Y2LX-6-06C	C-36	1YALX-3-025	C-28
1Y2LX-9-03	C-36	1YALX-3-03	C-28
1Y2LX-9-03C	C-36	1YALX-3-03C	C-28
1Y2LX-9-05	C-36	1YALX-3-04	C-28
1Y2LX-9-06C	C-36	1YALX-3-04C	C-28
1Y2LX-9-08	C-36	1YALX-3-05C	C-28
1Y2LX-9-08C	C-36	1YALX-4-02	C-28
1Y2LX-12-08C	C-36	1YALX-6-03	C-28
1Y2LX-12-12C4462	C-36	1YALX-6-03C	C-28
1Y2LX-16-12C4462	C-36	1YALX-6-04	C-28
1Y2LX-16-16C4462	C-36	1YALX-6-05	C-28
1Y42X-4-025	C-41, C-57	1YALX-6-05C	C-28
1Y42X-4-025C	C-41, C-57	1YALX-6-06	C-28
1Y42X-4-03	C-41, C-57, C-66	1YALX-6-06C	C-28
1Y42X-4-03C	C-41, C-57, C-66	1YALX-9-08	C-28
1Y42X-6-025	C-41	1YALX-9-08C	C-28
1Y42X-6-025C	C-41	1YBKY-2-04	C-16

Table of contents

Part number	page	Part number	page
1YBKY-4-04.....	C-16, C-19	2022N-06V15-10K.....	B-2
1YBKY-4-05.....	C-16	2022N-08V15-10K.....	B-2
1YBKY-6-05.....	C-16	216-200-18.....	E-2
1YBTX-2-025-PL.....	C-12	220-200-22.....	E-2
1YBTX-2-02-PL.....	C-12	2240D-025V32-TC.....	C-6
1YBTX-2-03-PL.....	C-12	2240D-02V32-TC.....	C-6
1YBTX-4-025-PL.....	C-12	2240D-03V32-TC.....	C-6
1YBTX-4-03-PL.....	C-12	2240D-04V32-TC.....	C-6
1YBTX-4-04-PL.....	C-12	2240D-025V62-HT-TC.....	C-6
1YBTX-4-05-PL.....	C-12	2240D-02V62-HT-TC.....	C-6
1YBTX-6-05-PL.....	C-12	2240D-03V62-HT-TC.....	C-6
1YHTX-4-025-PL.....	C-12	2240D-04V62-HT-TC.....	C-6
1YHTX-4-03-PL.....	C-12	2244N-025V00.....	B-5
1YHTX-4-03-PL-LH.....	C-12	2244N-06V00.....	B-5
1YHTX-6-03-PL-LH.....	C-12	2244N-08V10.....	B-5
1YHTX-6-04-PL.....	C-12	2248D-025V32-TC.....	C-7
1YHTX-6-04-PL-LH.....	C-12	2248D-03V32-TC.....	C-7
1YHTX-6-05-PL-LH.....	C-12	2248D-05V32-TC.....	C-7
1YM2X-6-025.....	C-41, C-57	2248D-025V62-HT-TC.....	C-7
1YM2X-6-03.....	C-41, C-57, C-66	2248D-03V62-HT-TC.....	C-7
1YM2X-6-03C.....	C-41, C-57, C-66	2248D-05V62-HT-TC.....	C-7
1YM2X-6-04.....	C-41	2380N-025V10.....	B-14
1YM2X-6-05.....	C-54, C-60, C-63	2380N-04V00.....	B-14
1YM2X-6-06.....	C-60	2380N-05V00.....	B-14
1YM2X-6-08.....	C-51	2380N-06V10.....	B-14
1YM2X-11-08.....	C-51, C-60	2380N-08V10.....	B-14
1YM2X-12-08.....	C-51, C-60	2380N-20V30.....	B-14
1YMJX-11-08.....	C-41	2380N-025V10W.....	C-13
1YMJX-12-08.....	C-41	2380N-04V00W.....	C-13
1YMLX-11-08.....	C-27	2380N-05V00W.....	C-13
1YMLX-6-05.....	C-27	2380N-06V10W.....	C-13
1YZTX-1-025-PL.....	C-11	2380N-08V10W.....	C-13
1YZTX-1-02-PL.....	C-11	2388N-04V00.....	B-21
1YZTX-2-025-PL.....	C-11	2388N-06V12.....	B-21
1YZTX-2-02-PL.....	C-11	2388N-04V12W.....	C-17
1YZTX-2-03-PL.....	C-11	2388N-06V12W.....	C-17
1YZTX-4-025-PL.....	C-11	2388N-08V12W.....	C-17
1YZTX-4-03-PL.....	C-11	2440D-025V32-TC.....	C-25
1YZTX-5-025-PL.....	C-11	2440D-025V32.....	C-24
1YZTX-5-04-PL.....	C-11	2440D-02V32-TC.....	C-25
2022N-04V15-10K.....	B-2	2440D-02V32.....	C-24

Part number	page	Part number	page
2440D-03V32-TC	C-25	6HYLX-9-5C-PL-LH	C-34
2440D-03V32	C-24	6HYLX-9-5C-PL	C-34
2440D-04V32-TC	C-25	6Y4LX-4-2AC	C-39
2440D-04V32	C-24	6Y4LX-6-2AC	C-39
2440D-05V32-TC	C-25	6YHLX-4-02-PL	C-33
2440D-05V32	C-24	6YHLX-4-2AC-PL-LH	C-33, C-38
2440N-06V30	C-24	6YHLX-4-2AC-PL	C-33, C-46
2440N-08V30	C-24	6YHLX-4-3C-PL-LH	C-33
2440N-12V30	C-24	6YHLX-4-3C-PL	C-33
2440N-16V30	C-24	6YHLX-6-2AC-PL-LH	C-33, C-38
2448D-025V32-TC	C-37	6YHLX-6-3C-PL-LH	C-33
2580N-06V12	C-21	6YHLX-6-3C-PL	C-33
2580N-08V12	C-21	6YHLX-6-4C-PL-LH	C-33
2580N-12V12	C-21	6YHLX-6-4C-PL	C-33
2640D-03V32	C-40	6YHLX-9-4C-PL	C-33
2640D-04V32	C-40	6YHLX-9-5C-PL-LH	C-33
2640N-08V32	C-40	6YHLX-9-5C-PL	C-33
2640N-12V32	C-40	ESH200-08	C-2
2640N-16V32	C-40	ESH200-12	C-2
2648N-12V32	C-48	ESH200-16	C-2
2648N-16V32	C-48	ESH200-20	C-2
508-J-500-10	E-2	ESH250-08	C-4
510-A-500-12	E-2	ESH250-12	C-4
520-A-500-26	E-2	ESH250-16	C-4
612-400-14	E-2	ESH250-20	C-4
620-100-18	E-2	HPK-HS-8	D-5
65YLX-6-3C	C-35	HPK-HSP-8	D-5
65YLX-6-4C	C-35	HS-03	E-4
66YLX-4-3	C-35	HS-05	E-4
692LX-16-16C	C-29	HS-08	E-4
6AYLX-16-16C	C-27	HS-12	E-4
6AYLX-6-2AC	C-39	HS-16	E-4
6HYLX-4-2AC-PL-LH	C-34, C-38	KL-03	E-4
6HYLX-4-2AC-PL	C-34, C-38	KL-05	E-4
6HYLX-4-3C-PL-LH	C-34	KL-08	E-4
6HYLX-4-3C-PL	C-34	KL-12	E-4
6HYLX-6-2AC-PL-LH	C-34, C-38	KL2543	E-4
6HYLX-6-3C-PL-LH	C-34	MHDC010	E-2
6HYLX-6-3C-PL	C-34	MHDC011	E-2
6HYLX-6-4C-PL-LH	C-34	MHDC012	E-2
6HYLX-6-4C-PL	C-34	MHDC014	E-2

Table of contents

Part number	page	Part number	page
MHDC016	E-2	PVC-S-12	E-4
MHDC018	E-2	PVC-S-16	E-4
MHDC020	E-2	TMCAP-8.....	D-5
MHDC022	E-2	TMCAP-9.....	D-5
MHDC024	E-2	UHPLABEL	E-4
MHDC026	E-2		
MHDC032	E-2		
MK022-03-038	E-3		
MK022-03-039	E-3		
MK022-03-041	E-3		
MK022-03-042	E-3		
MK022-03-043	E-3		
MK022-03-045	E-3		
MSG060	E-3		
MSG2006	E-3		
MSG2106	E-3		
MSG4113	E-3		
MSG4120	E-3		
MSG4125	E-3		
PFX21-02.....	C-50		
PFX21-03.....	C-50		
PFX21-08.....	C-50		
PFX21-08-TJ.....	C-50		
PFX25-05.....	C-53		
PFX25-05-TJ.....	C-53		
PFX30-025.....	C-56		
PFX30-03.....	C-56		
PFX30-03TJ.....	C-56		
PFX30-05.....	C-56		
PFX30-05-TJ.....	C-56		
PFX30-06.....	C-56		
PFX30-06-TJ.....	C-56		
PFX30-08.....	C-56		
PFX30-08-TJ.....	C-56		
PFX38-05.....	C-62		
PFX38-05-TJ.....	C-62		
PFX40-03.....	C-65		
PFX40-03-TJ.....	C-65		
PVC-S-03	E-4		
PVC-S-05	E-4		
PVC-S-08	E-4		

Part number	page	Part number	page
-------------	------	-------------	------

For Your Safety

The hose assemblies listed in this catalogue are all special constructions with the hose having up to eight spiral layers of steel wire. Due to this construction, pressures are achieved which far exceed German and international standards. These hose types are manufactured and tested according to the Polyflex standards which have proved to be effective over many years.

Polyflex hose assemblies are used at considerable working pressures. The critical area of a hose assembly is the connection between flexible hose and rigid fitting (crimping area). Only the use of original Polyflex components (hose, fittings and tooling) and full compliance with the Polyflex assembly instructions can guarantee safety and conformity with standards. It is essential that training be given to customers in the hose assembly process in order to make high quality Polyflex maximum pressure hose assemblies.

For the production and testing of the hose assemblies relevant to the applications, the guidelines and technical regulations as well as the protection and hazard prevention rulings must be adhered to.

You as the manufacturer of Polyflex hose assemblies are obliged to mark these hose assemblies according to the regulations and to verify their safety by a final pressure test.

Non-compliance with these rules can lead to the premature failure of the hose assembly and the loss of warranty.



Parker's Motion & Control Technologies

At Parker, we're guided by a relentless drive to help our customers become more productive and achieve higher levels of profitability by engineering the best systems for their requirements. It means looking at customer applications from many angles to find new ways to create value. Whatever the motion and control technology need, Parker has the experience, breadth of product and global reach to consistently deliver. No company knows more about motion and control technology than Parker. For further info call 00800 27 27 5374



Aerospace

Key Markets

Aftermarket services
Commercial transports
Engines
General & business aviation
Helicopters
Launch vehicles
Military aircraft
Missiles
Power generation
Regional transports
Unmanned aerial vehicles

Key Products

Control systems & actuation products
Engine systems & components
Fluid conveyance systems & components
Fluid metering, delivery & atomization devices
Fuel systems & components
Fuel tank inerting systems
Hydraulic systems & components
Thermal management
Wheels & brakes



Climate Control

Key Markets

Agriculture
Air conditioning
Construction Machinery
Food & beverage
Industrial machinery
Life sciences
Oil & gas
Precision cooling
Process
Refrigeration
Transportation

Key Products

Accumulators
Advanced actuators
CO₂ controls
Electronic controllers
Filter driers
Hand shut-off valves
Heat exchangers
Hose & fittings
Pressure regulating valves
Refrigerant distributors
Safety relief valves
Smart pumps
Solenoid valves
Thermostatic expansion valves



Electromechanical

Key Markets

Aerospace
Factory automation
Life science & medical
Machine tools
Packaging machinery
Paper machinery
Plastics machinery & converting
Primary metals
Semiconductor & electronics
Textile
Wire & cable

Key Products

AC/DC drives & systems
Electric actuators, gantry robots & slides
Electrohydraulic actuation systems
Electromechanical actuation systems
Human machine interface
Linear motors
Stepper motors, servo motors, drives & controls
Structural extrusions



Filtration

Key Markets

Aerospace
Food & beverage
Industrial plant & equipment
Life sciences
Marine
Mobile equipment
Oil & gas
Power generation & renewable energy
Process
Transportation
Water Purification

Key Products

Analytical gas generators
Compressed air filters & dryers
Engine air, coolant, fuel & oil filtration systems
Fluid condition monitoring systems
Hydraulic & lubrication filters
Hydrogen, nitrogen & zero air generators
Instrumentation filters
Membrane & fiber filters
Microfiltration
Sterile air filtration
Water desalination & purification filters & systems



Fluid & Gas Handling

Key Markets

Aerial lift
Agriculture
Bulk chemical handling
Construction machinery
Food & beverage
Fuel & gas delivery
Industrial machinery
Life sciences
Marine
Mining
Mobile
Oil & gas
Renewable energy
Transportation

Key Products

Check valves
Connectors for low pressure fluid conveyance
Deep sea umbilicals
Diagnostic equipment
Hose couplings
Industrial hose
Mooring systems & power cables
PTFE hose & tubing
Quick couplings
Rubber & thermoplastic hose
Tube fittings & adapters
Tubing & plastic fittings

Hydraulics

Key Markets

Aerial lift
Agriculture
Alternative energy
Construction machinery
Forestry
Industrial machinery
Machine tools
Marine
Material handling
Mining
Oil & gas
Power generation
Refuse vehicles
Renewable energy
Truck hydraulics
Turf equipment

Key Products

Accumulators
Cartridge valves
Electrohydraulic actuators
Human machine interfaces
Hybrid drives
Hydraulic cylinders
Hydraulic motors & pumps
Hydraulic systems
Hydraulic valves & controls
Hydrostatic steering
Integrated hydraulic circuits
Power take-offs
Power units
Rotary actuators
Sensors

Pneumatics

Key Markets

Aerospace
Conveyor & material handling
Factory automation
Life science & medical
Machine tools
Packaging machinery
Transportation & automotive

Key Products

Air preparation
Brass fittings & valves
Manifolds
Pneumatic accessories
Pneumatic actuators & grippers
Pneumatic valves & controls
Quick disconnects
Rotary actuators
Rubber & thermoplastic hose & couplings
Structural extrusions
Thermoplastic tubing & fittings
Vacuum generators, cups & sensors

Process Control

Key Markets

Alternative fuels
Biopharmaceuticals
Chemical & refining
Food & beverage
Marine & shipbuilding
Medical & dental
Microelectronics
Nuclear Power
Offshore oil exploration
Oil & gas
Pharmaceuticals
Power generation
Pulp & paper
Steel
Water/wastewater

Key Products

Analytical Instruments
Analytical sample conditioning products & systems
Chemical injection fittings & valves
Fluoropolymer chemical delivery fittings, valves & pumps
High purity gas delivery fittings, valves, regulators & digital flow controllers
Industrial mass flow meters/ controllers
Permanent no-weld tube fittings
Precision industrial regulators & flow controllers
Process control double block & bleeds
Process control fittings, valves, regulators & manifold valves

Sealing & Shielding

Key Markets

Aerospace
Chemical processing
Consumer
Fluid power
General industrial
Information technology
Life sciences
Microelectronics
Military
Oil & gas
Power generation
Renewable energy
Telecommunications
Transportation

Key Products

Dynamic seals
Elastomeric o-rings
Electro-medical instrument design & assembly
EMI shielding
Extruded & precision-cut, fabricated elastomeric seals
High temperature metal seals
Homogeneous & inserted elastomeric shapes
Medical device fabrication & assembly
Metal & plastic retained composite seals
Shielded optical windows
Silicone tubing & extrusions
Thermal management
Vibration dampening

ENGINEERING YOUR SUCCESS.

www.parker.com



Parker Hannifin Manufacturing Germany GmbH & Co. KG

polyflex **Division**

An der Tuchbleiche 4

68623 Lampertheim (Hüttenfeld)

Tel.: +49 (0)6256 81-0

Fax: +49 (0)6256 81-123

www.parker.com/polyflex

polyflex@parker.com